

KENWOOD®
HI/FI STEREO COMPONENTS

SERVICE MANUAL

KR-80 (KR-80L)

An item of adjustment is written in three languages – English, French and German.

Un article sur réglages est écrit en trois langues, Anglais, Français et Allemand.

Ein Artikel der Abgleich wird auf drei Sprachen, Englische, Französich und Deutsch geschrieben

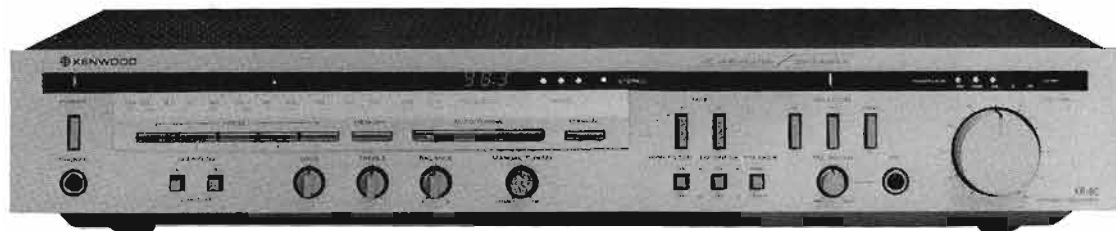

STEREO RECEIVER

CONTENTS

EXTERNAL VIEW (KR-80).....	3
EXTERNAL VIEW (KR-80L).....	4
INTERNAL VIEW.....	5
DISASSEMBLY.....	6
EXPLODED VIEW.....	7
BLOCK AND LEVEL DIAGRAM.....	8
ADJUSTMENT.....	9-10
ADJUSTMENT - REGLAGES (FR).....	11-12
ADJUSTMENT - ABGLEICH (DE).....	13-14
ADJUSTMENT INSTRUMENTS US/FR/DE.....	15-16
PC BOARD - TUNER.....	17-18
PC BOARD - AUDIO AMP.....	19-20
SCHEMATIC AND SPECIFICATIONS (KR-80).....	21a-d
SCHEMATIC AND SPECIFICATIONS (KR-80L).....	22a-d
PARTS LIST.....	23-27

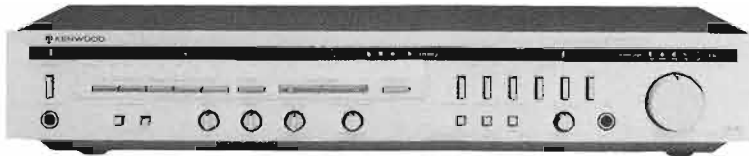

Photo is KR-80L

Note:

Component and circuitry are subject to modification to insure best operation under differing local conditions. This manual is based on the U.S. (K) standard, and provides information on regional circuit modification through use of alternate schematic diagrams, and information on regional component variations through use of parts list.

	Region	Code
KR-80	U.S.A.	K
	Canada	P
	PX (Far East)	U
	PX (Europe)	UE
	Australia	X
	South Africa	S
	England	T
	Europe and Scandinavia	E
	Other Areas	M
	Audio Club	H
KR-80L	England	T
	Europe and Scandinavia	E

There is no plan for producing units of S type.

EXTERNAL VIEW(KR-80)

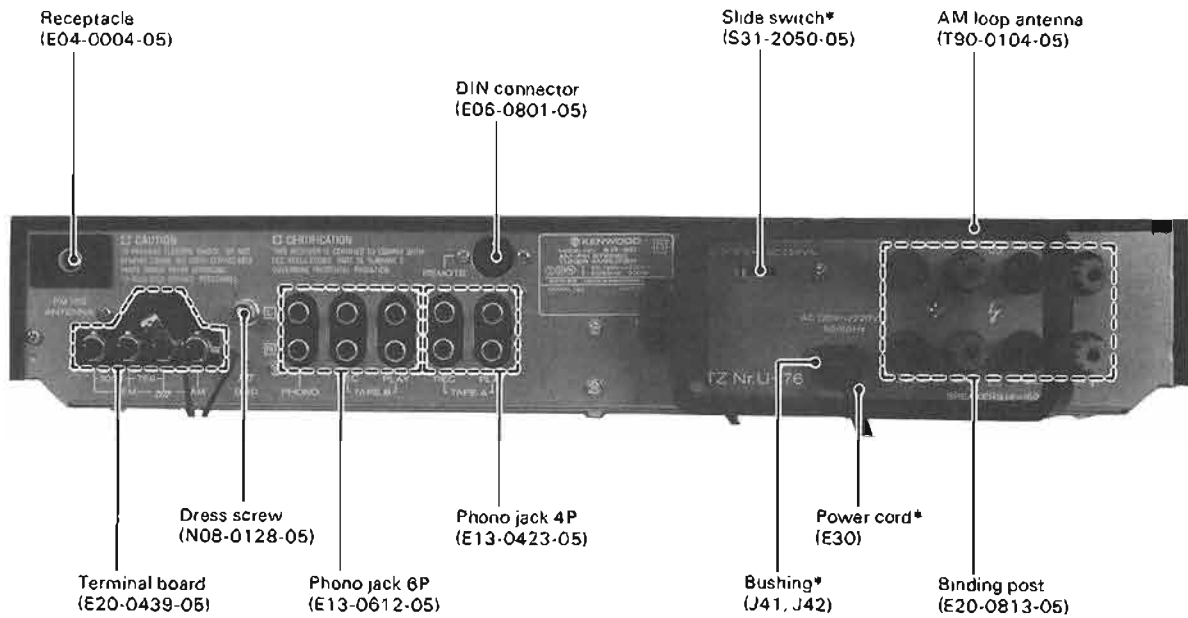
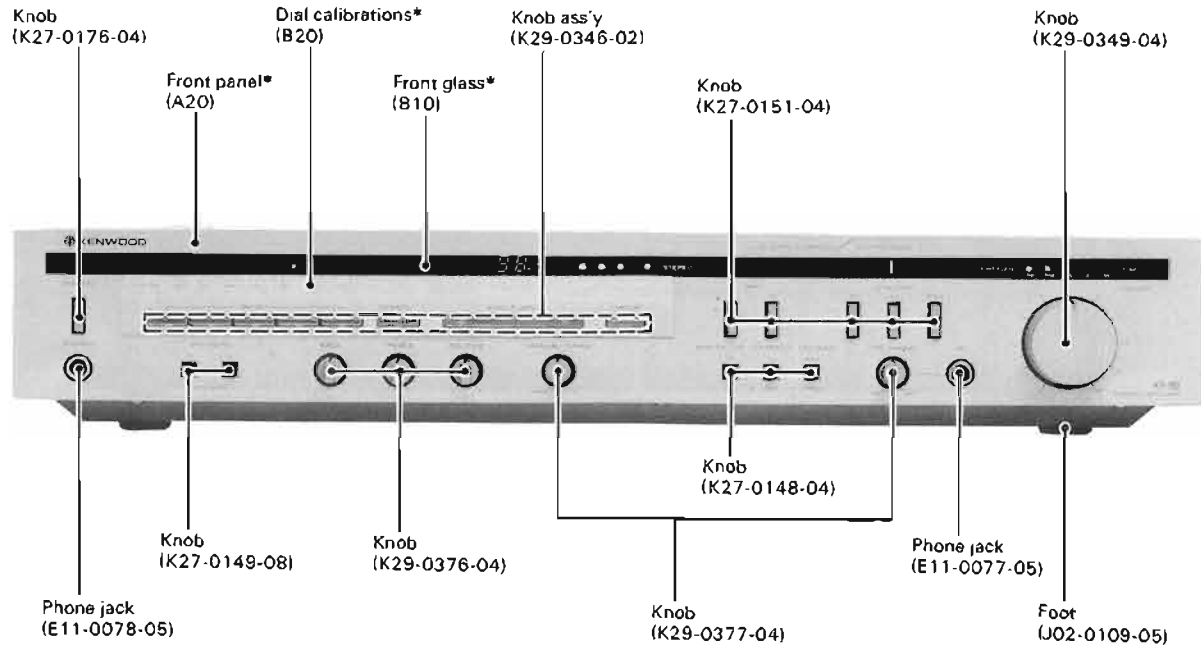

Photo is E type.
* Refer to Parts List.

EXTERNAL VIEW(KR-80L)

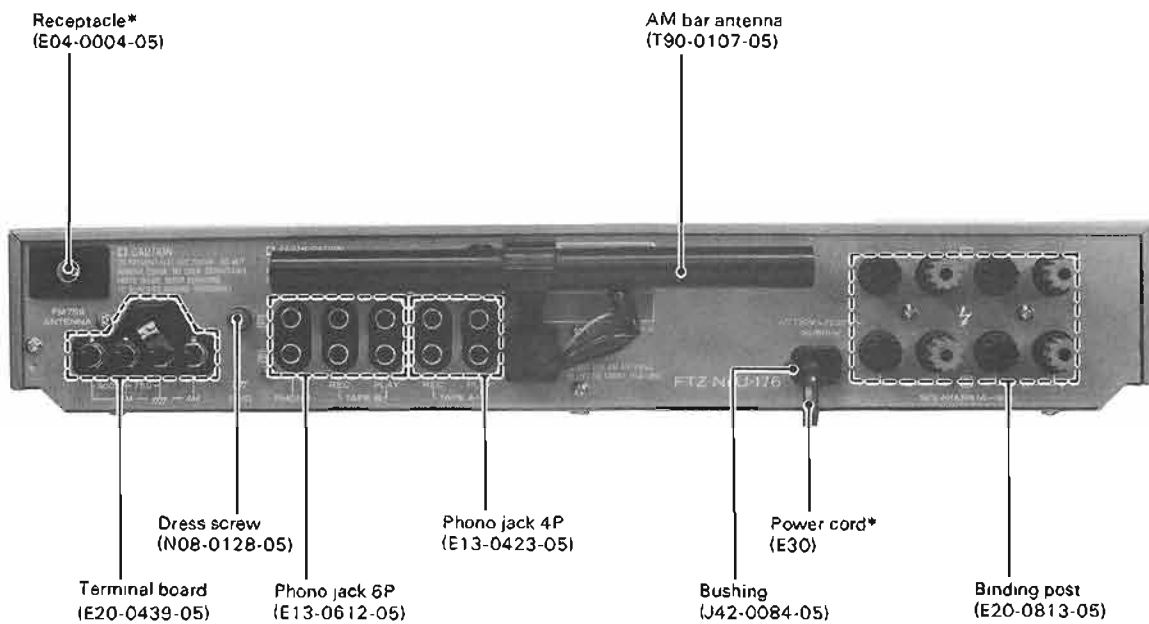
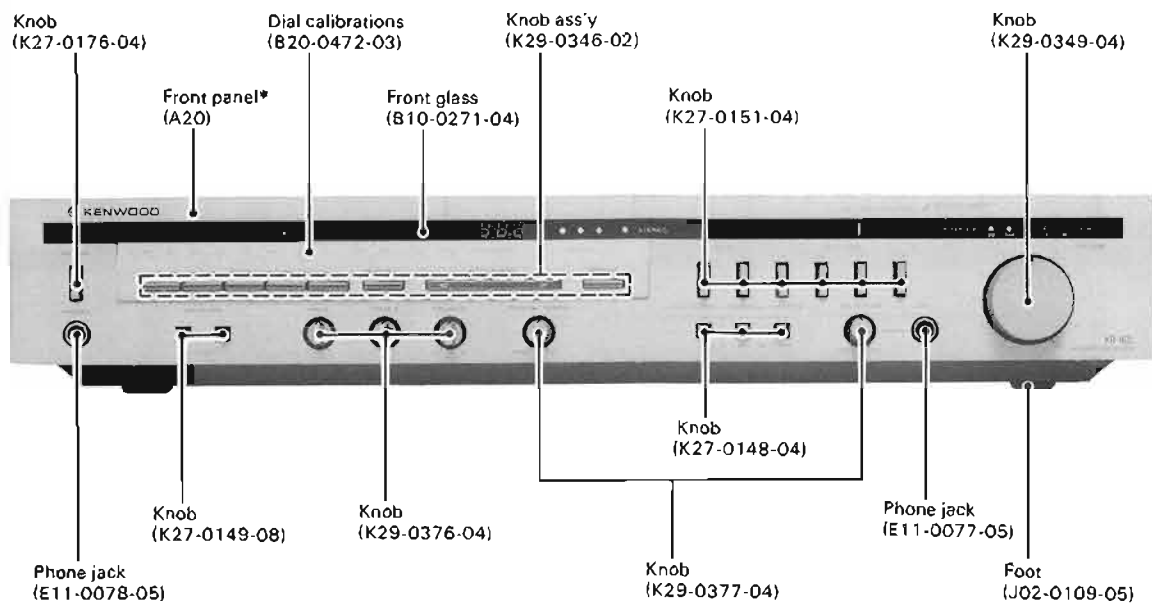
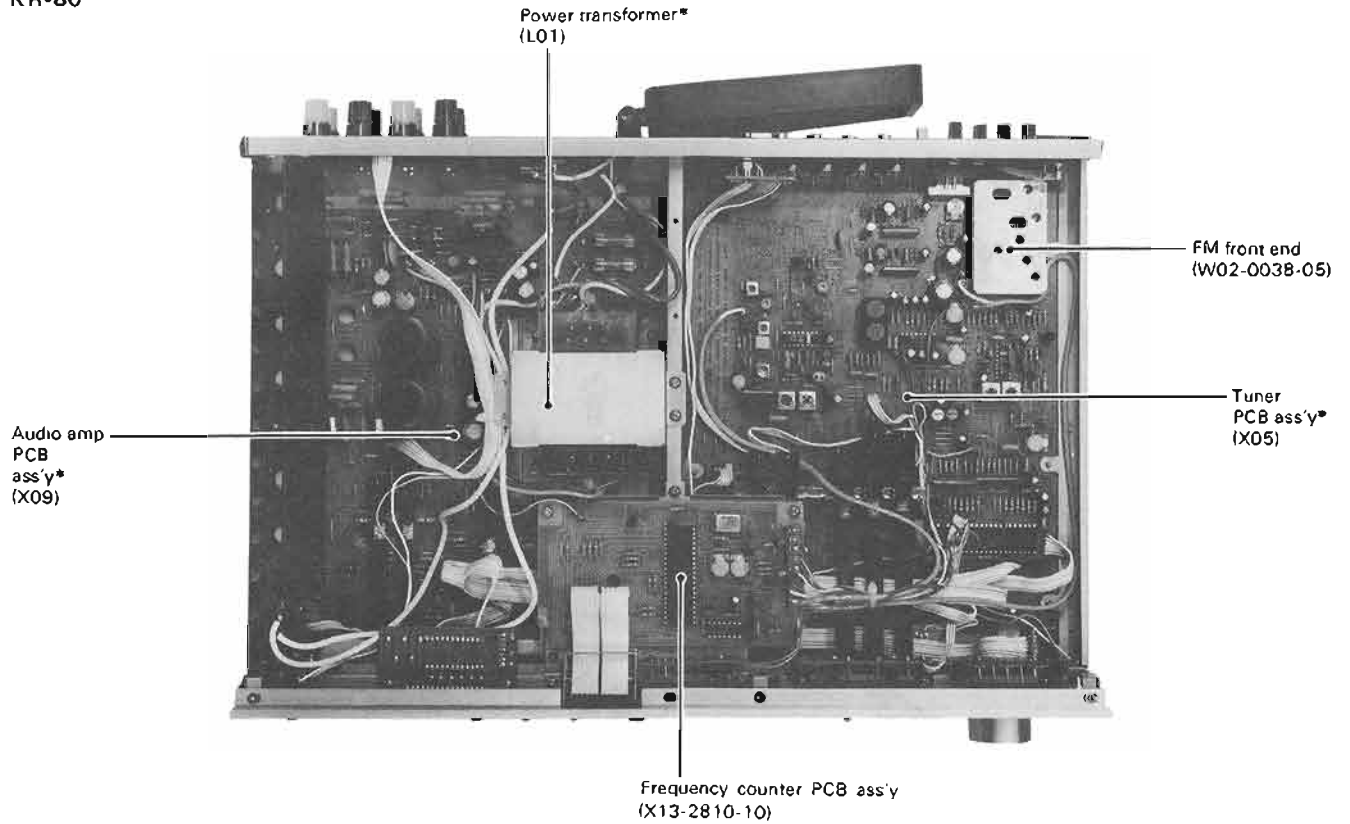

Photo is E type.
*Refer to Parts List.

INTERNAL VIEW

KR-80



KR-80L

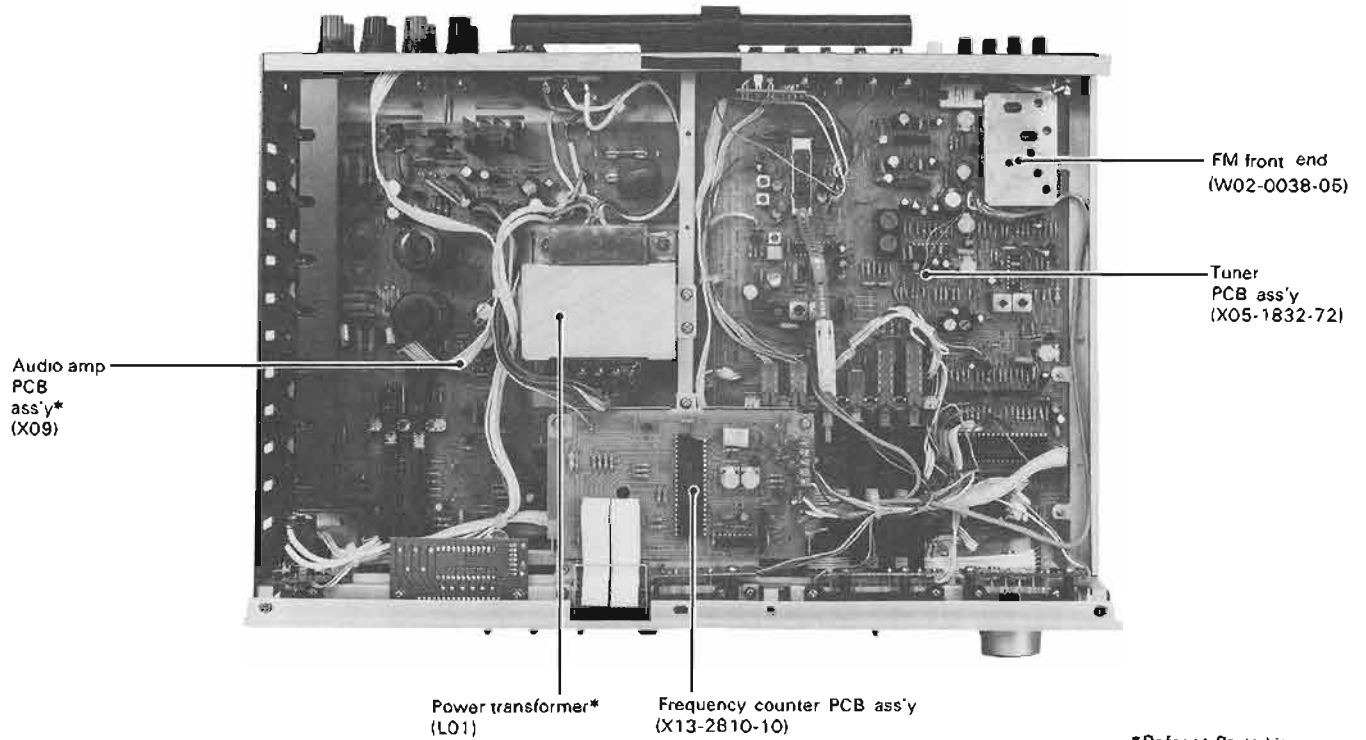

*Refer to Parts List.

DISASSEMBLY

DETACHMENT OF FREQUENCY COUNTER PCB ASS'Y

- ① Remove the screw fixing the frequency display.
- ② Remove the screws fixing the frequency counter PCB ass'y
- ③ Then, the frequency counter PCB ass'y can be removed.

Note:

This detachment is needed when adjusting VR1. 2 (tuner PCB ass'y) and VR4. 5 (audio PCB ass'y)

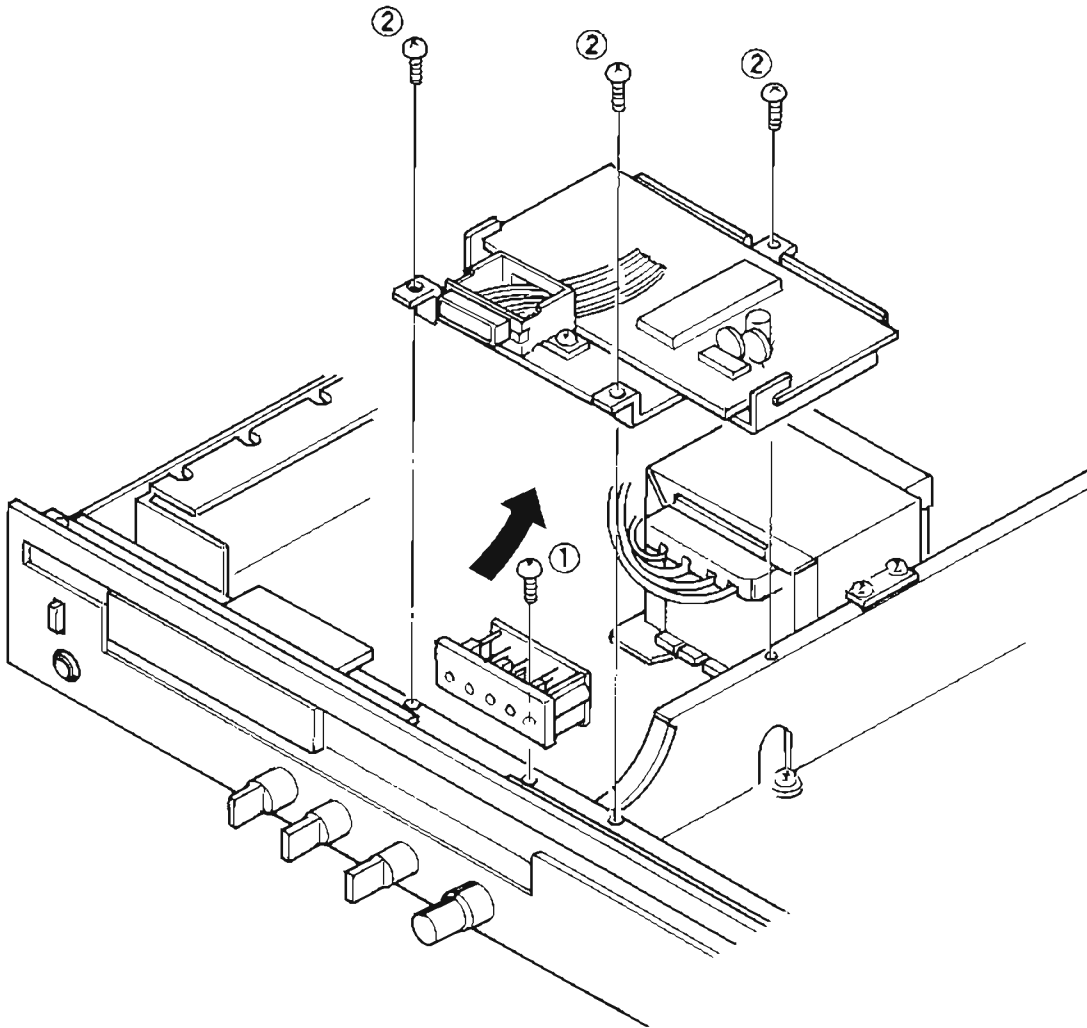

BLOCK & LEVEL DIAGRAM

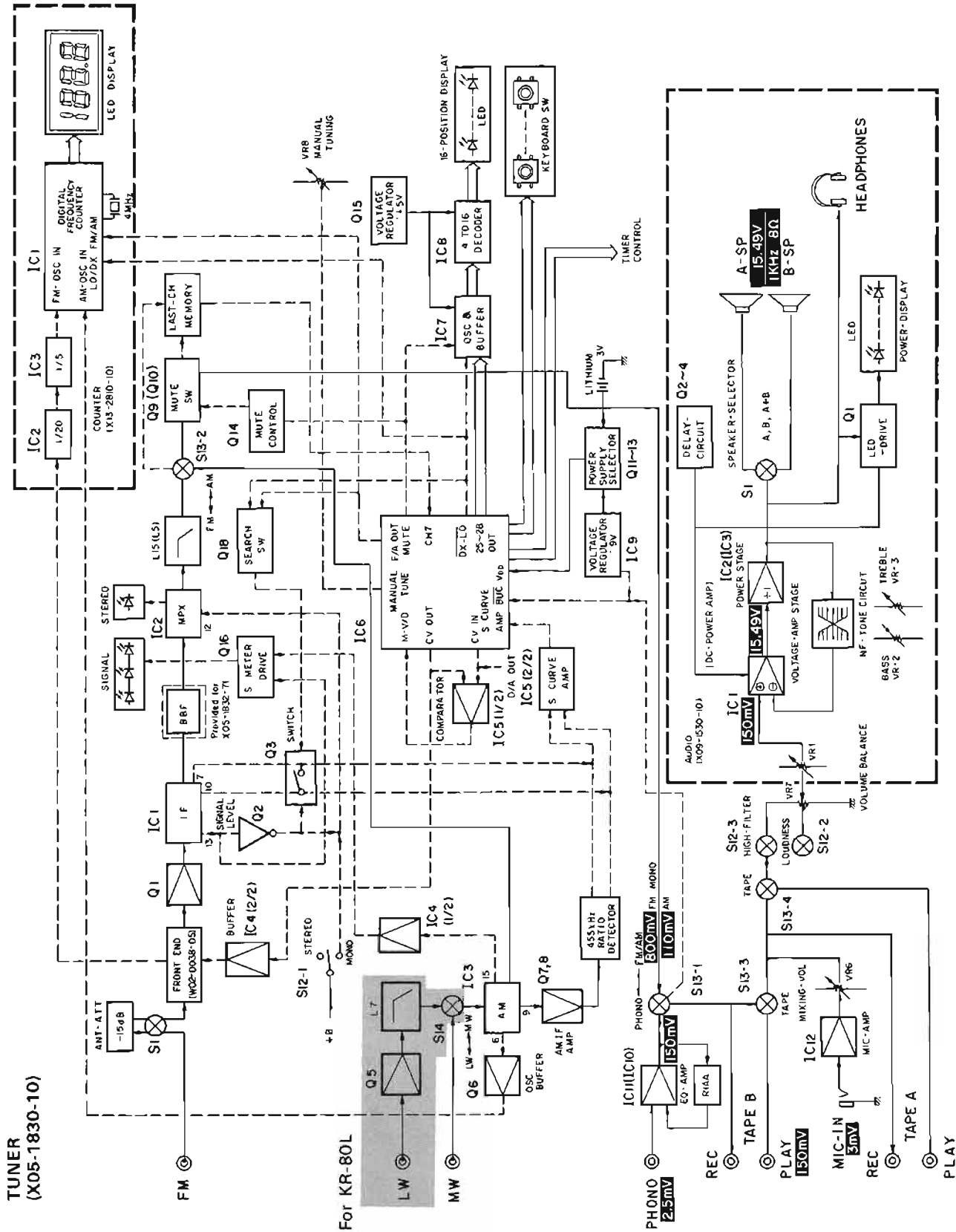

ADJUSTMENT

See page 16.

NO.	ITEM	SYSTEM CONNECTIONS	TEST EQUIPMENT SETTING	TUNER (RECEIVER) SETTING	ALIGNMENT POINTS	ALIGN FOR	FIG. NO.
FM							
1	REFERENCE VOLTAGE	Connect a DC voltmeter to the junction of R1 and R3.	—	FM	VR5 (X05-1830-10)	DC voltage for ground: 8.05V ±0.05V	(a)
2	S CURVE CENTER OFFSET	Connect a DC voltmeter to pin 8 of IC5 AN6551 (J87)	—	PHONO	VR4 (X05-1830-10)	DC voltage for ground: 4.75V	(b)
3	DISCRIMINATOR (1)	(A)/Connect a DC voltmeter to pin 8 of IC5 AN6551 (J87)	98 MHz 0 dev 60 dB (ANT input)	FM, MANUAL MANUAL TUNING 98 MHz	L2 (X05-1830-10)	DC voltage for ground: 4.75V	(b)
4	DISCRIMINATOR (2)	(A)/(B)	98 MHz 1 kHz ± 75 kHz dev 60 dB (ANT input)	FM, MANUAL MANUAL TUNING 98 MHz	L3 (X05-1830-10)	Minimum distortion	
5	VCO	(A)/Connect a frequency counter to the junction of R35 and VR2 via an AC voltmeter.	98 MHz 0 dev 60 dB (ANT input)	FM STEREO AUTO TUNING 98 MHz	VR2 (X05-1830-10)	Frequency: 76 kHz ±200 Hz	(c)
VCO: Voltage Controlled Oscillator							
6	SEPARATION	(C)/(B)	98 MHz 1 kHz ± 68.25 kHz dev Selector: L or R Pilot: ± 6.75 kHz dev 60 dB (ANT input)	FM STEREO AUTO TUNING 98 MHz	VR3 (X05-1830-10)	Minimum crosstalk. A compromise adjustment may be required if left-to-right and right-to-left separations are unequal	
7	DISTORTION (STEREO)	(C)/(B)	98 MHz 1 kHz ± 68.25 kHz dev Selector: L or R Pilot: ± 6.75 kHz dev 60 dB (ANT input)	FM STEREO AUTO TUNING 98 MHz	T1 (W02-0038-05)	Minimum distortion	
AM (KR-80)							
Keep the AM loop antenna installed.							
(1)	IF TRANSFORMER	(D)/(B)	1000 kHz 400 Hz, 30% mod	AM AUTO TUNING 1000 kHz	L10 (X05-1830-10)	Maximum amplitude and symmetry of the oscilloscope display	
(2)	AM BAND EDGE (HIGH)	—	—	AM, MANUAL/ Fully turn the MANUAL TUNING knob clockwise (until it becomes free)	TC1 (X05-1830-10)	Frequency display reading: 1650	
(3)	AM BAND EDGE (LOW)	—	—	AM, MANUAL/ Fully turn the MANUAL TUNING knob counterclockwise (until it becomes free).	VR1 (X05-1830-10)	Adjust VR1 so that the frequency counter reads 515. If the specified value cannot be obtained, adjust L9 and VR1	
(4)	RF ALIGNMENT (AM)	(D)/(B)	600 kHz 400 Hz, 30% mod	AM AUTO TUNING 600 kHz	L6 (X05-1830-10)	Maximum amplitude and symmetry of the oscilloscope display.	
(5)	RF ALIGNMENT (AM)	(D)/(B)	1400 kHz 400 Hz, 30% mod	AM AUTO TUNING 1400 kHz	TC2 (X05-1830-10)	Maximum amplitude and symmetry of the oscilloscope display.	
Repeat alignments (4) and (5) several times							
(6)	DISCRIMINATOR (AM)	(D)/Connect a DC voltmeter to pin 8 of IC5 AN6551	1400 kHz 400 Hz, 30% mod 25 dB (ANT input)	AM, MANUAL MANUAL TUNING 1400 kHz	L13 (X05-1830-10)	DC voltage for ground: 4.75V	(b)

ADJUSTMENTS

NO.	ITEM	SYSTEM CONNECTIONS	TEST EQUIPMENT SETTING	TUNER (RECEIVER) SETTING	ALIGNMENT POINTS	ALIGN FOR	FIG. NO.
AM (KR-80L)							
[1]	IF TRANSFORMER	(D)/(B)	1000 kHz 400 Hz, 30% mod	AM AUTO TUNING 1000 kHz	L10 (X05-1830-10)	Maximum amplitude and symmetry of the oscilloscope display	
[2]	AM BAND EDGE (HIGH)	—	—	AM, MANUAL/ Fully turn the MANUAL TUNING knob clockwise (until it becomes free)	TC1 (X05-1830-10)	Frequency display reading: 1650	
[3]	AM BAND EDGE (LOW)	—	—	AM, MANUAL/ Fully turn the MANUAL TUNING knob counterclockwise (until it becomes free).	VR1 (X05-1830-10)	Adjust VR1 so that the frequency counter reads 515. If the specified value cannot be obtained, adjust L9 and VR1	
[4]	RF ALIGNMENT (AM)	(D)/(B)	600 kHz 400 Hz, 30% mod	AM AUTO TUNING 600 kHz	AM ferrite bar antenna (A)	Maximum amplitude and symmetry of the oscilloscope display	
[5]	RF ALIGNMENT (AM)	(D)/(B)	1400 kHz 400 Hz, 30% mod	AM AUTO TUNING 1400 kHz	TC2 (X05-1830-10)	Maximum amplitude and symmetry of the oscilloscope display.	
Repeat alignments [4] and [5] several times.							
[6]	LW BAND EDGE (HIGH)	—	—	LW, MANUAL/ Fully turn the MANUAL TUNING knob clockwise (until it becomes free).	TC3 (X05-1830-10)	Frequency display reading: 355	
[7]	LW BAND EDGE (LOW)	—	—	LW, MANUAL/ Fully turn the MANUAL TUNING knob counterclockwise (until it becomes free)	L8	Frequency display reading: 145	
[8]	RF ALIGNMENT (LW)	(D)/(B)	170 kHz 400 Hz, 30% mod	LW 170 kHz	AM ferrite bar antenna (B)	Maximum amplitude and symmetry of the oscilloscope display.	
[9]	RF ALIGNMENT (LW)	(D)/(B)	325 kHz 400 Hz, 30% mod	LW 325 kHz	TC4 (X05-1830-10)	Maximum amplitude and symmetry of the oscilloscope display.	
RF = radio frequency							
[10]	DISCRIMINATOR (AM)	(D)/Connect a DC voltmeter to pin 8 of IC5 AN6551	1400 kHz 400 Hz, 30% mod 25 dB (ANT input)	AM, MANUAL MANUAL TUNING 1400 kHz	L13 (X05-1830-10)	DC voltage for ground: 4.75V	(b)
FREQUENCY DISPLAY							
I	FREQUENCY DISPLAY (FM)	(A)/Insert a 4.7kΩ resistor between pins 10 and 11 of IC1 LC7259 (X13-2810-10)	89.10 MHz 0 dev 60 dB (ANT input)	FM-MONO AUTO TUNING 89.1 MHz	VR1 (X13-2810-10)	Adjust VR1 so that the frequency display reads 89.1 and stops flickering	(d)
II	FREQUENCY DISPLAY (AM)	(D)/Insert a 6.8kΩ resistor between pins 7 and 11 of IC1 LC7259 (X13-2810-10)	1440.0 kHz 0 mod 60 dB (ANT input)	AM AUTO TUNING 1440.0 kHz	VR2 (X13-2810-10)	Adjust VR2 so that the frequency display reads 1440.0 and stops flickering	(e)
POWER AMP							
i	OFFSET	Connect a DC voltmeter between terminal 8 (9) of X09-1530-10 and the ground.	—	PHONO VOLUME: 0	VR4 (L ch) VR5 (R ch)	0V	(f)

REGLAGES

Voir la page 16.

N°	ITEM	RACCORDEMENTS DU SYSTEME	REGLAGE DE L'APPAREILLAGE	REGLAGE DU TUNER (AMPLI-TUNER)	POINTS DE L'ALIGNEMENT	ALIGNER POUR	FIG. N°
MF							
1	TENSION DE REFERENCE	Connecter un voltmètre CC à la jonction de R1 et R3	—	FM	VR5 (X05-1830-10)	Tension continue pour terre: 8,05V ± 0,05V	(a)
2	DESAXAGE DE CENTRE DE COURBE S	Connecter un voltmètre CC à la fiche 8 de IC5 AN6551 (J87)	—	PHONO	VR4 (X05-1830-10)	Tension continue pour terre 4,75V	(b)
3	DISCRIMINATEUR (1)	(A)/Connecter un voltmètre CC à la fiche 8 de IC5 AN6551 (J87).	98 MHz 0 dév 60 dB (Entrée ANT)	FM. MANUAL accord manuel 98 MHz	L2 (X05-1830-10)	Tension continue pour terre. 4,75V	(b)
4	DISCRIMINATEUR	(A)/(B)	98 MHz 1 kHz ± 75 kHz dév 60 dB (Entrée ANT)	idem	L3 (X05-1830-10)	Distortion minimale	
5	OSCILLATEUR CONTROLE PAR LA TENSION	(A)/Connecter un compteur de fréquence à la jonction de R35 et VR2 par un voltmètre CA.	98 MHz 0 dév 60 dB (Entrée ANT)	FM STEREO accord automatique 98 MHz	VR2 (X05-1830-10)	Fréquence. 76 kHz ± 200 Hz	(c)
6	SEPARATION	(C)/(B)	98 MHz 1 kHz ± 68,25 kHz dév SELECTION: L ou R Signal pilote ± 6,75 kHz dév 60 dB (Entrée ANT)	FM STEREO accord automatique 98 MHz	VR3 (X05-1830-10)	Diaphonie minimale Un compromis de réglage peut être nécessaire si les séparations de gauche à droite et de droite à gauche sont inégales	
7	DISTORSION (STEREO)	(C)/(B)	98 MHz 1 kHz ± 68,25 kHz dév SELECTION: L ou R Signal pilote. ± 6,75 kHz dév 60 dB (Entrée ANT)	FM STEREO accord automatique 98 MHz	T1 (W02-0038-05)	Distorsion minimale	
MA (KR-80)							
Laisser l'antenne boucle MA installée.							
(1)	TRANS-FORMATEUR F.I.	(D)/(B)	1000 kHz 400 Hz, 30% mod	AM/accord automatique 1000 kHz	L10 (X05-1830-10)	Amplitude et symétrie maximale de l'affichage de l'oscilloscope	
(2)	BORD DE BANDE (HAUT)	—	—	AM, MANUAL/ Tourner le bouton MANUAL TUNING vers la droite à fond (jusqu'à ce qu'il devienne libre)	TC1 (X05-1830-10)	La lecture de l'affichage de fréquence. 1650	
(3)	BORD DE BANDE (BAS)	—	—	AM, MANUAL/ Tourner le bouton MANUAL TUNING vers la gauche à fond (jusqu'à ce qu'il devienne libre).	VR1 (X05-1830-10)	Régler VR1 en sorte que le compteur de fréquence donne une lecture de 515. Si la valeur spécifiée ne peut pas être obtenue, régler L9 et VR1	
(4)	ALIGNEMENT H.T. (MA)	(D)/(B)	600 kHz 400 Hz, 30% mod	AM/accord automatique 600 kHz	L6 (X05-1830-10)	Amplitude et symétrie maximale de l'affichage de l'oscilloscope	
(5)	ALIGNEMENT H.T. (MA)	(D)/(B)	1400 kHz 400 Hz, 30% mod	AM/accord automatique 1400 kHz	TC2 (X05-1830-10)	Amplitude et symétrie maximale de l'affichage de l'oscilloscope	
Répéter les alignements (4) et (5) plusieurs fois.							
(6)	DISCRIMINATEUR (MA)	(D)/Connecter un voltmètre CC à la fiche 8 de IC5 AN6551 (J87).	1400 kHz 400 Hz, 30% mod 25 dB (Entrée ANT)	AM, MANUAL accord manuel 1400 kHz	L13 (X05-1830-10)	Tension continue pour terre: 4,75V	(b)

REGLAGES

N°	ITEM	RACCORDEMENTS DU SYSTEME	REGLAGE DE L'APPAREILLAGE	REGLAGE DU TUNER (AMPLI-TUNER)	POINTS DE L'ALIGNEMENT	ALIGNER POUR	FIG. N°
MA (KR-80L)							
[1]	TRANSFORMATEUR F.I.	(D)/(B)	1000 kHz 400 Hz, 30% mod	AM/accord automatique 1000 kHz	L10 (X05-1830-10)	Amplitude et symétrie maximale de l'affichage de l'oscilloscope.	
[2]	BORD DE BANDE (HAUT)	-	-	AM, MANUAL/ Tourner le bouton MANUAL TUNING vers la droite à fond (jusqu'à ce qu'il devienne libre)	TC1 (X05-1830-10)	La lecture de l'affichage de fréquence 1650	
[3]	BORD DE BANDE (BAS)	-	-	AM, MANUAL/ Tourner le bouton MANUAL TUNING vers la gauche à fond (jusqu'à ce qu'il devienne libre)	VR1 (X05-1830-10)	Régler VR1 en sorte que le compteur de fréquence donne une lecture de 515. Si la valeur spécifiée ne peut pas être obtenue, régler L9 et VR1	
[4]	ALIGNEMENT H.T. (MA)	(D)/(B)	600 kHz 400 Hz, 30% mod	AM/accord automatique 600 kHz	Antenne MA (A)	Amplitude et symétrie maximale de l'affichage de l'oscilloscope	
[5]	ALIGNEMENT H.T. (MA)	(D)/(B)	1400 kHz 400 Hz, 30% mod	AM/accord automatique 1400 kHz	TC2 (X05-1830-10)	Amplitude et symétrie maximale de l'affichage de l'oscilloscope.	
Répéter les alignements [4] et [5] plusieurs fois							
[6]	BORD DE BANDE (HAUT)	-	-	LW, MANUAL/ Tourner le bouton MANUAL TUNING vers la droite à fond (jusqu'à ce qu'il devienne libre).	TC3 (X05-1830-10)	La lecture de l'affichage de fréquence 355	
[7]	BORD DE BANDE (BAS)	-	-	LW, MANUAL/ Tourner le bouton MANUAL TUNING vers la gauche à fond (jusqu'à ce qu'il devienne libre).	L8	La lecture de l'affichage de fréquence: 145	
[8]	ALIGNEMENT H.T. (LW)	(D)/(B)	170 kHz 400 Hz, 30% mod	LW 170 kHz	Antenne MA (B)	Amplitude et symétrie maximale de l'affichage de l'oscilloscope.	
[9]	ALIGNEMENT H.T. (LW)	(D)/(B)	325 kHz 400 Hz, 30% mod	LW 325 kHz	TC4 (X05-1830-10)	Amplitude et symétrie maximale de l'affichage de l'oscilloscope	
H T. = haute fréquence							
[10]	DISCRIMINATEUR (MA)	(D)/Connecter un voltmètre CC à la fiche 8 de IC5 AN6551 (J87).	1400 kHz 400 Hz 30% mod 25 dB (Entrée ANT)	AM, MANUAL accord manuel 1400 kHz	L13 (X05-1830-10)	Tension continue pour terre. 4.75V	(b)
AFFICHAGE FREQUENCY							
I	AFFICHAGE FREQUENCY (MF)	(A)/Insérer un résistor de 4,7kΩ entre les fiches 10 et 11 de IC1 LC7259 (X13-2810-10)	89,10 MHz 0 dév 60 dB (Entrée ANT)	FM-MONO accord automatique 89,1 MHz	VR1 (X13-2810-10)	Régler VR1 en sorte que la lecture de l'affichage de fréquence soit de 89,1 et l'affichage s'arrêtera de papilloter	(d)
II	AFFICHAGE FREQUENCY (MA)	(D)/Insérer un résistor de 6,8kΩ entre les fiches 7 et 11 de IC1 LC7259 (X13-2810-10)	1440,0 kHz 0 mod 60 dB (Entrée ANT)	AM accord automatique 1440 kHz	VR2 (X13-2810-10)	Régler VR2 en sorte qu la lecture de l'affichage de fréquence soit de 1440 et l'affichage s'arrêtera de papilloter	(e)
AMPLIFICATEUR DE PUISSANCE							
i	DECALAGE (OFFSET)	Connecter un voltmètre CC entre terminale 8(9) de X09-1530-10 et la terre	-	PHONO VOLUME 0	VR4 (gauche) VR5 (droit)	0V	(f)

ABGLEICH

Sehen den page 16

NR.	GEGENSTAND	SYSTEM-ANSCHLÜSSE	PRÜFEIN-RICHTUNG-EINSTELLUNG	TUNER (RECEIVER)-EINSTELLUNG	ABGLEICH-PUNKTE	ABGLEICHEN FÜR	ABB. NR.
UKW							
1	REFERENZ-SPANNUNG	Einen Gleichspannungsmesser zur Verbindung von R1 und R3 anschließen	—	FM	VR5 (X05-1830-10)	Gleichspannung für Erde 8,05V ±0,05V	(a)
2	ZENTRUM-ABWEICHUNG DER S-KURVE	Einen Gleichspannungsmesser zum Stift 8 von IC5 AN6551 (J87)	—	PHONO	VR4 (X05-1830-10)	Gleichspannung für Erde 4,75V	(b)
3	DISKRIMINATOR (1)	(A)/Einen Gleichspannungsmesser zum Stift 8 von IC5 AN6551 (J87)	98 MHz 0 Hub 60 dB (ANT-Eingang)	FM. MANUAL manuelle Abstimmung 98 MHz	L2 (X05-1830-10)	Gleichspannung für Erde 4,75V	(b)
4	DISKRIMINATOR (2)	(A)/(B)	98 MHz 1 kHz ±75 kHz Hub 60 dB (ANT-Eingang)	FM. MANUAL manuelle Abstimmung	L3 (X05-1830-10)	Minimaler Klirrfaktor	
5	SPANNUNGS-GEREGELTER OSZILLATOR	(A)/Einen Frequenzmesser zur Verbindung von R35 und VR2 über einem Wechselspannungsmesser anschließen.	98 MHz 0 Hub 60 dB (ANT-Eingang)	FM STEREO automatische Abstimmung 98 MHz	VR2 (X05-1830-10)	Frequenz 76 kHz ±200 Hz	(c)
6	STEREO KANAL TRENNUNG	(C)/(B)	98 MHz 1 kHz ±68,25 kHz Hub Wähler L oder R Pilotton: ±6,75 kHz Hub 60 dB (ANT-Eingang)	FM STEREO automatische Abstimmung 98 MHz	VR3 (X05-1830-10)	Minimales Übersprechen Eine Ausgleichregelung kann notwendig sein, falls links-zu-rechts und rechts-zu-links Trennungen ungleich sind.	
7	KLIRRFAKTOR (STEREO)	(C)/(B)	98 MHz 1 kHz ±68,25 kHz Hub Wähler L oder R Pilotton ±6,75 kHz Hub 60 dB (ANT-Eingang)	FM STEREO automatische Abstimmung 98 MHz	T1 (W02-0038-05)	Minimaler Klirrfaktor	
MW (KR-80)							
Die MW-Rahmenantenne angebracht lassen.							
(1)	ZF-ÜBERTRAGER	(D)/(B)	1000 kHz 400 Hz, 30% mod	AM automatische Abstimmung 1000 kHz	L10 (X05-1830-10)	Maximale Amplitude und Symmetrie des Oszilloskopbildes	
(2)	MW BANDKANTE (HOCH)	—	—	AM. MANUAL/ Den MANUAL TUNING Knopf ganz nach rechts drehen (bis er frei wird)	TC1 (X05-1830-10)	Die Ablesung des Frequenzbildes 1650	
(3)	MW BANDKANTE (NIEDRIG)	—	—	AM. MANUAL/ Den MANUAL TUNING Knopf ganz nach links drehen (bis er frei wird)	VR1 (X05-1830-10)	VR1 so einstellen, daß die Ablesung des Frequenzbildes 515 ist. Falls der angegebene Wert nicht erreicht werden kann, L9 und VR1 regeln	
(4)	HF-ABGLEICH (MW)	(D)/(B)	600 kHz 400 Hz, 30% mod	AM/automatische Abstimmung 600 kHz	L6 (X05-1830-10)	Maximale Amplitude und Symmetrie des Oszilloskopbildes	
(5)	HF-ABGLEICH (MW)	(D)/(B)	1400 kHz 400 Hz, 30% mod	AM/automatische Abstimmung 1400 kHz	TC2 (X05-1830-10)	Maximale Amplitude und Symmetrie des Oszilloskopbildes.	
Abstimmungen [4] und [5] mehrere Male wiederholen.							
(6)	DISKRIMINATOR (MW)	Einen Gleichspannungsmesser zum Stift 8 von IC5 AN6551 (J87)	1400 kHz 400 Hz, 30% mod 25 dB (ANT-Eingang)	AM. MANUAL manuelle Abstimmung 1400 kHz	L13 (X05-1830-10)	Gleichspannung für Erde 4,75V	(b)

ABGLEICH

NR.	GEGENSTAND	SYSTEM-ANSCHLÜSSE	PRÜFEIN-RICTUNG-EINSTELLUNG	TUNER (RECEIVER)-EINSTELLUNG	ABGLEICH-PUNKTE	ABGLEICHEN FÜR	ABB. NR.
MW/LW (KR-80L)							
(1)	ZF-ÜBERTRAGER	(D)/(B)	1000 kHz 400 Hz, 30% mod	AM/ automatische Abstimmung 1000 kHz	L10 (X05-1830-10)	Maximale Amplitude und Symmetrie des Oszilloskopbildes.	
(2)	MW BANDKANTE (HOCH)	—	—	AM, MANUAL/ Den MANUAL TUNING Knopf ganz nach rechts drehen (bis er frei wird)	TC1 (X05-1830-10)	Die Ablesung des Frequenzbildes: 1650	
(3)	MW BANDKANTE (NIEDRIG)	—	—	AM, MANUAL/ Den MANUAL TUNING Knopf ganz nach links drehen (bis er frei wird)	VR1 (X05-1830-10)	VR1 so einstellen, daß die Ablesung des Frequenzbildes 515 ist. Falls der angegebene Wert nicht erreicht werden kann, L9 und VR1 regeln	
(4)	HF- ABGLEICH (MW)	(D)/(B)	600 kHz 400 Hz, 30% mod	AM/automatische Abstimmung 600 kHz	MW- Ferritantenne (B)	Maximale Amplitude und Symmetrie des Oszilloskopbildes.	
(5)	HF- ABGLEICH (MW)	(D)/(B)	1400 kHz 400 Hz, 30% mod	AM/automatische Abstimmung 1400 kHz	TC2 (X05-1830-10)	Maximale Amplitude und Symmetrie des Oszilloskopbildes.	
Abstimmungen [4] und [5] mehrere Male wiederholen							
(6)	LW BANDKANTE (HOCH)	—	—	LW, MANUAL/ Den MANUAL TUNING Knopf ganz nach rechts drehen (bis er frei wird).	TC3 (X05-1830-10)	Die Ablesung des Frequenzbildes: 355	
(7)	LW BANDKANTE (NIEDRIG)	—	—	LW, MANUAL/ Den MANUAL TUNING Knopf ganz nach links drehen (bis er frei wird)	L8	Die Ablesung des Frequenzbildes 145	
(8)	HF- ABGLEICH (LW)	(D)/(B)	170 kHz 400 Hz, 30% mod	LW 170 kHz	MW- Ferritantenne (B)	Maximale Amplitude und Symmetrie des Oszilloskopbildes.	
(9)	HF- ABGLEICH (LW)	(D)/(B)	325 kHz 400 Hz, 30% mod	LW 325 kHz	TC4 (X05-1830-10)	Maximale Amplitude und Symmetrie des Oszilloskopbildes.	
HF = Hochfrequenz							
(10)	DISKRIMI- NATOR (MW)	Einen Gleichspan- nungsmesser zum Stift 8 von IC5 AN6551 (J87)	1400 kHz 400 Hz, 30% mod 25 dB (ANT-Eingang)	AM, MANUAL manuelle Abstimmung 1400 kHz	L13 (X05-1830-10)	Gleichspannung für Erde 4,75V	(b)
FREQUENZANZEIGE							
I	DIGITAL- FREQUENZ- ANZEIGE (UKW)	(A)/Einen 4,7kΩ Widerstand zwischen Stifte 10 und 11 von IC1 LC7259 (X13-2810-10) einführen	89,10 MHz 0 Hub 60 dB (ANT-Eingang)	FM-MONO automatische Abstimmung 89,1 MHz	VR1 (X13-2810-10)	VR1 so einstellen, daß die Ablesung des Frequenzbildes 89,1 ist und das Bild zu flickern aufhört.	(d)
II	DIGITAL- FREQUENZ- ANZEIGE (MW)	(D)/Einen 6,8kΩ Widerstand zwischen Stifte 7 und 11 von IC1 LC7259 (X13-2810-10) einführen.	1440,0 kHz 0 mod 60 dB (ANT-Eingang)	AM automatische Abstimmung 1440 kHz	VR22 (X13-2810-10)	VR22 so einstellen, daß die Ablesung des Frequenzbildes 1440 ist und das Bild zu flickern aufhört	(e)
ENDVERSTÄRKER							
i	VERSCHIE- BUNG (OFFSET)	Einen Gleichspan- nungsmesser zwischen Klemme 8 von X09-1530-10 und der Erde.	—	PHONO VOLUME: 0	VR4 (linken Kanal) VR5 (rechten Kanal)	0V	(f)

ADJUSTMENT / REGLAGES / ABGLEICH

TEST INSTRUMENT

Oscilloscope
 AM signal generator
 FM signal generator
 Audio generator
 AC voltmeter
 FM multiplex generator
 Frequency counter
 DC voltmeter
 Distortion meter
 Dummy antenna

APPAREILLAGE

Oscilloscope
 Générateur MA
 Générateur MF
 Générateur audio fréquences
 Voltmètre CA
 Générateur multiplex stéréo
 Fréquencemètre
 Voltmètre CC
 Distorsiomètre
 Antenna fictive

PRÜFINSTRUMENTE

Oszilloskop
 MW-Signalgenerator
 UKW-Signalgenerator
 NF-Signalgenerator
 Wechselspannungsmesser
 UKW-Multiplexgenerator
 Frequenzzähler
 Gleichspannungsmesser
 Klirrfaktormesser
 Antennennachbildung

SCOPE
 AM-SG
 FM-SG
 AG

FM-MPX

SYSTEM CONNECTIONS/RACCORDEMENTS DU SYSTEME/SYSTEM-ANSCHLÜSSE

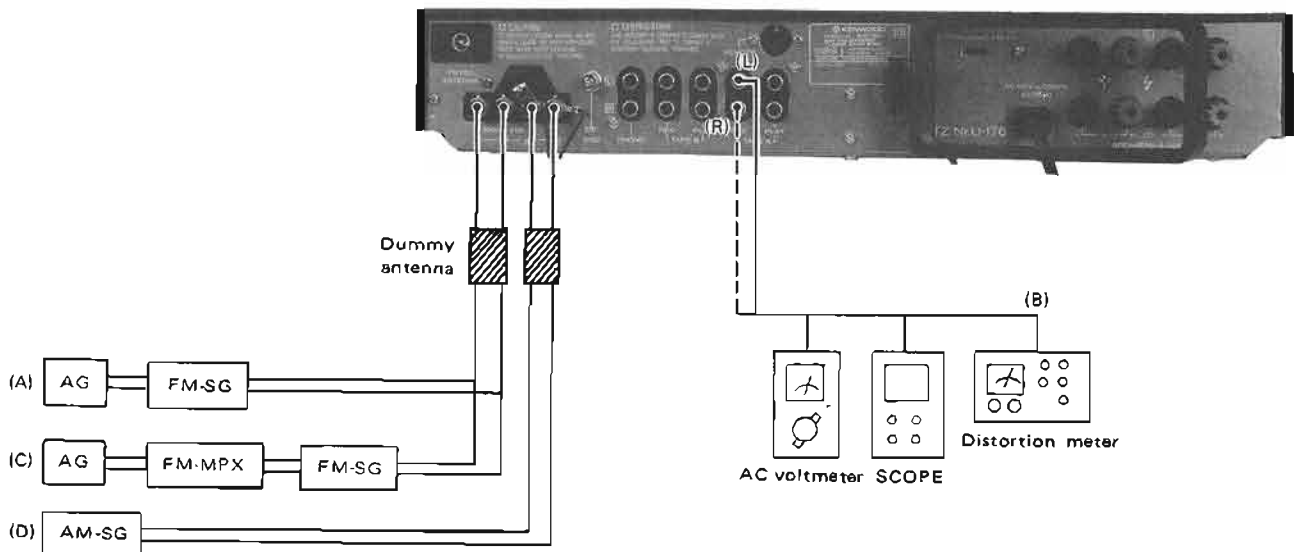

ADJUSTMENT/REGLAGES/ABGLEICH

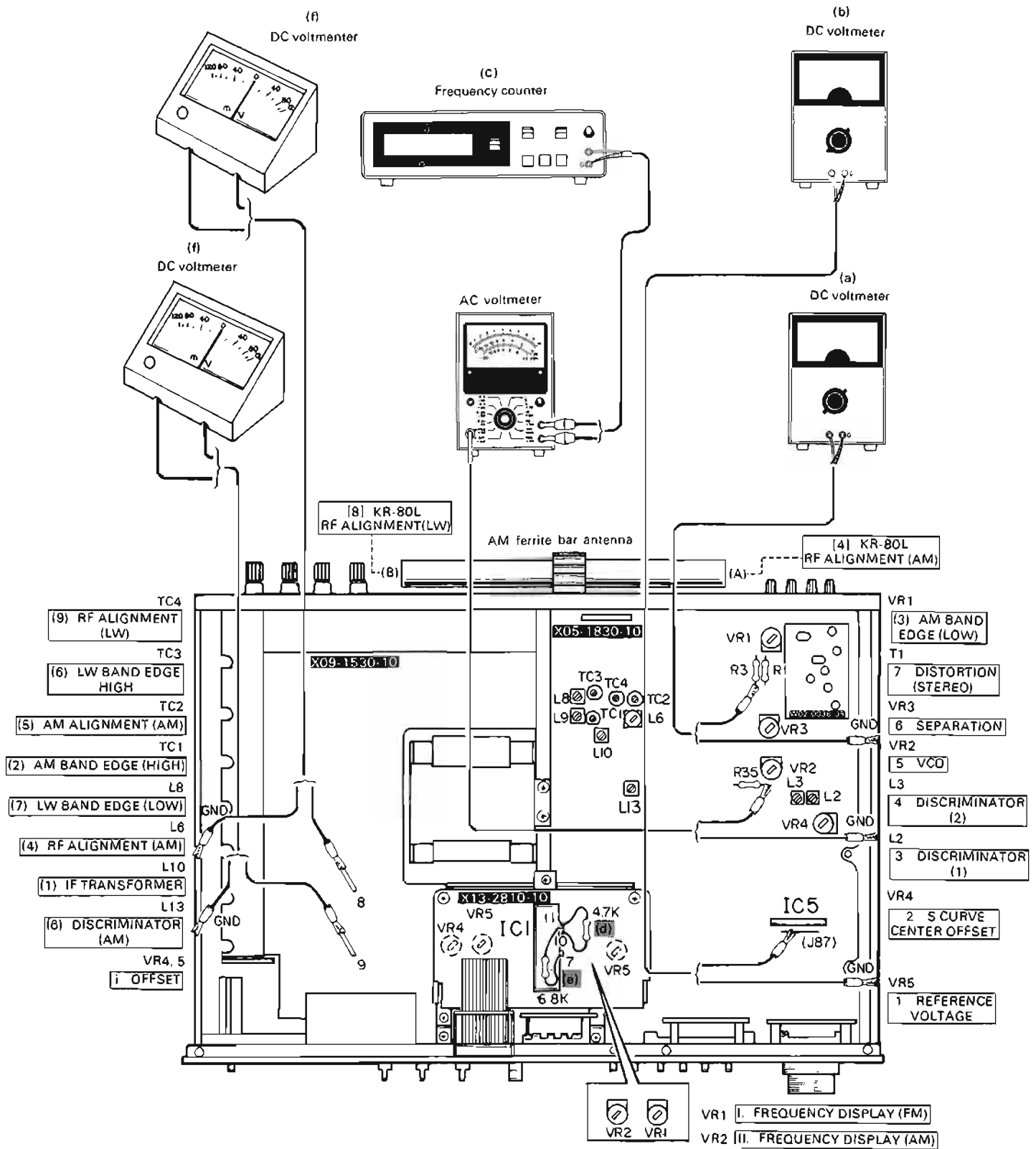

PC BOARD

TUNER (X05-1830-10, 81, X05-1832-71, 72)
Component side view

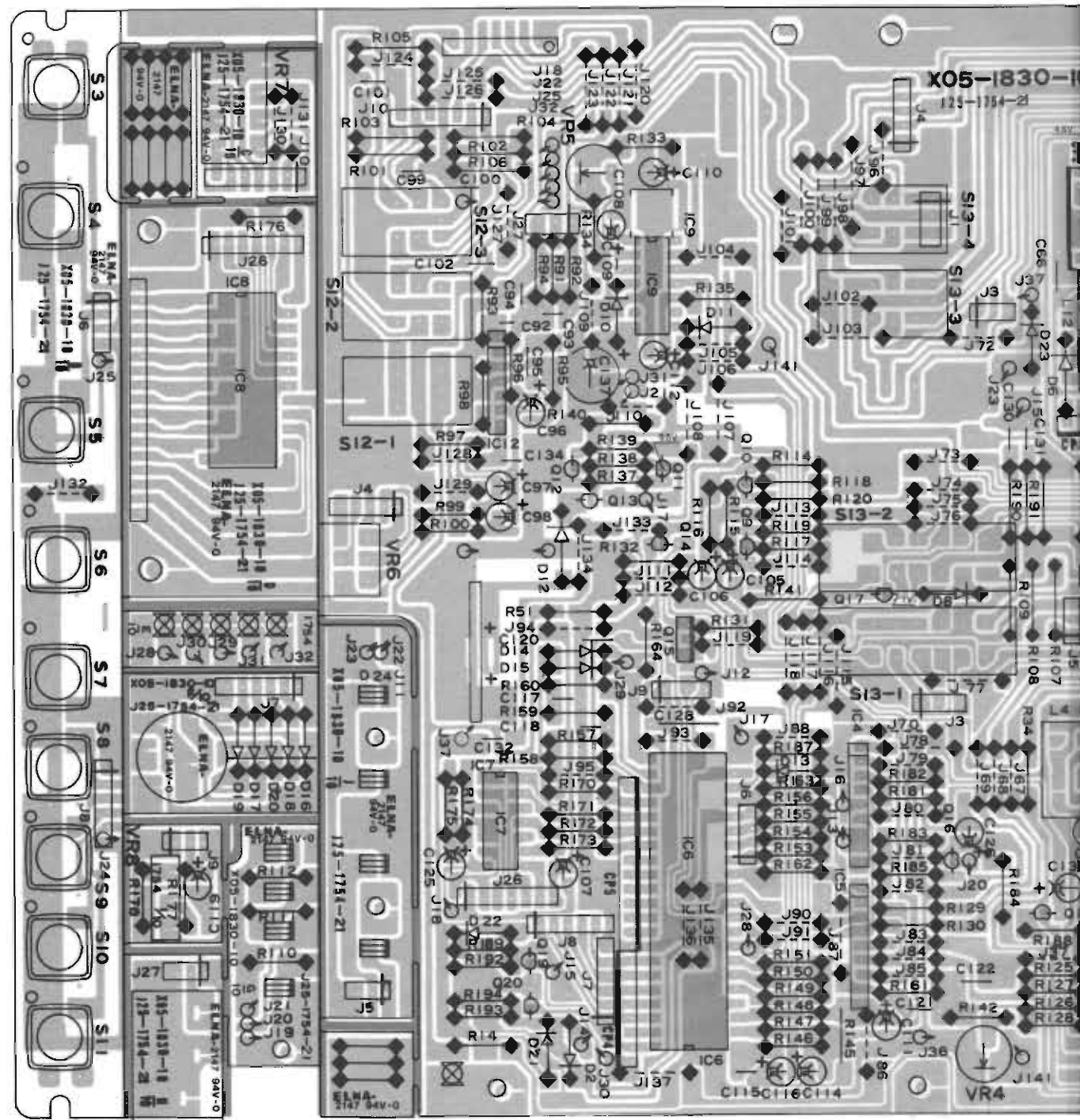
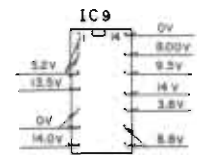

	D4	D5	D4	D5	D23	D24	TC3	CF1	S2	S3	S4	L4	L7	L14	VR3	R25	R55	C13	C25	C27	C33	C40	C44	C45	C47	C48		
X05-1830-10	NO	NO	NO	NO	NO	NO	NO	NO	NO	NO	NO	NO	NO	NO	NO	NO	NO	NO	NO	NO	NO	NO	NO	NO	NO	NO	NO	
X05-1830-81	NO	NO	NO	NO	NO	NO	NO	NO	NO	NO	NO	NO	NO	NO	NO	NO	NO	NO	NO	NO	NO	NO	NO	NO	NO	NO	NO	NO
X05-1832-71	YES	NO	NO	NO	NO	NO	NO	NO	NO	NO	NO	NO	NO	NO	NO	NO	NO	NO	NO	NO	NO	NO	NO	NO	NO	NO	NO	NO
X05-1832-72	YES	YES	NO	NO	NO	NO	NO	NO	NO	NO	NO	NO	NO	NO	NO	NO	NO	NO	NO	NO	NO	NO	NO	NO	NO	NO	NO	NO

* Refer to Schematic Diagram and/or Ports List

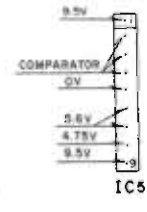
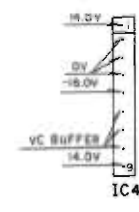

PC BOARD

: Regional circuit modification

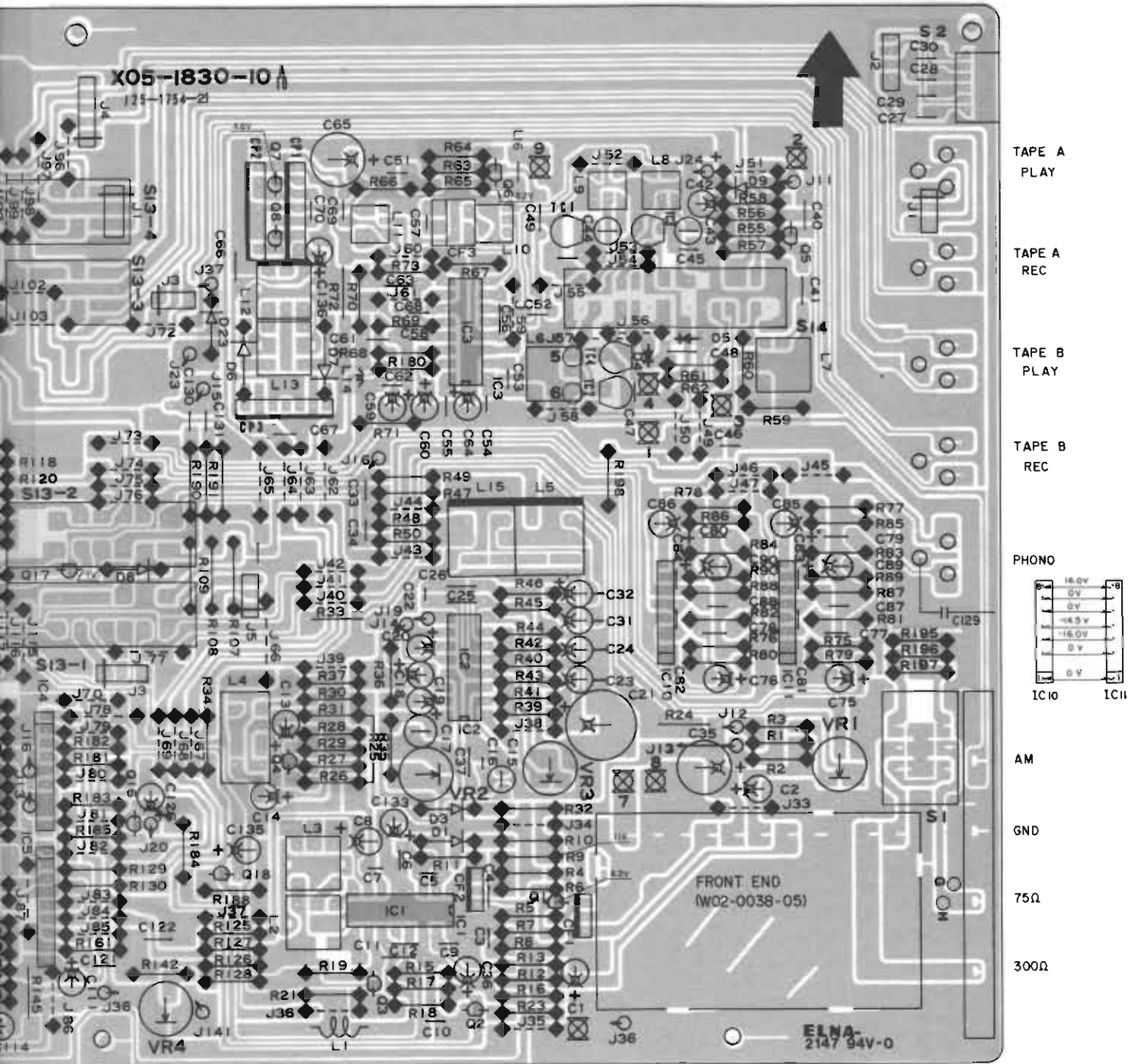

TAPE A
PLAY

TAPE A
REC

TAPE B
PLAY

TAPE B
REC

PHONO

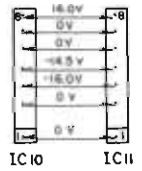

AM

GND

75Ω

300Ω

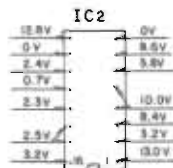
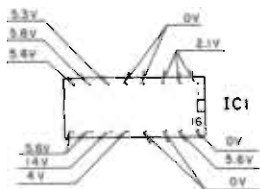

Refer to the schematic diagram for the values or resistors and capacitors.

AUDIO AMP (X09-1530-10, 51, 81, X09-1532-71, 72)
Component side view

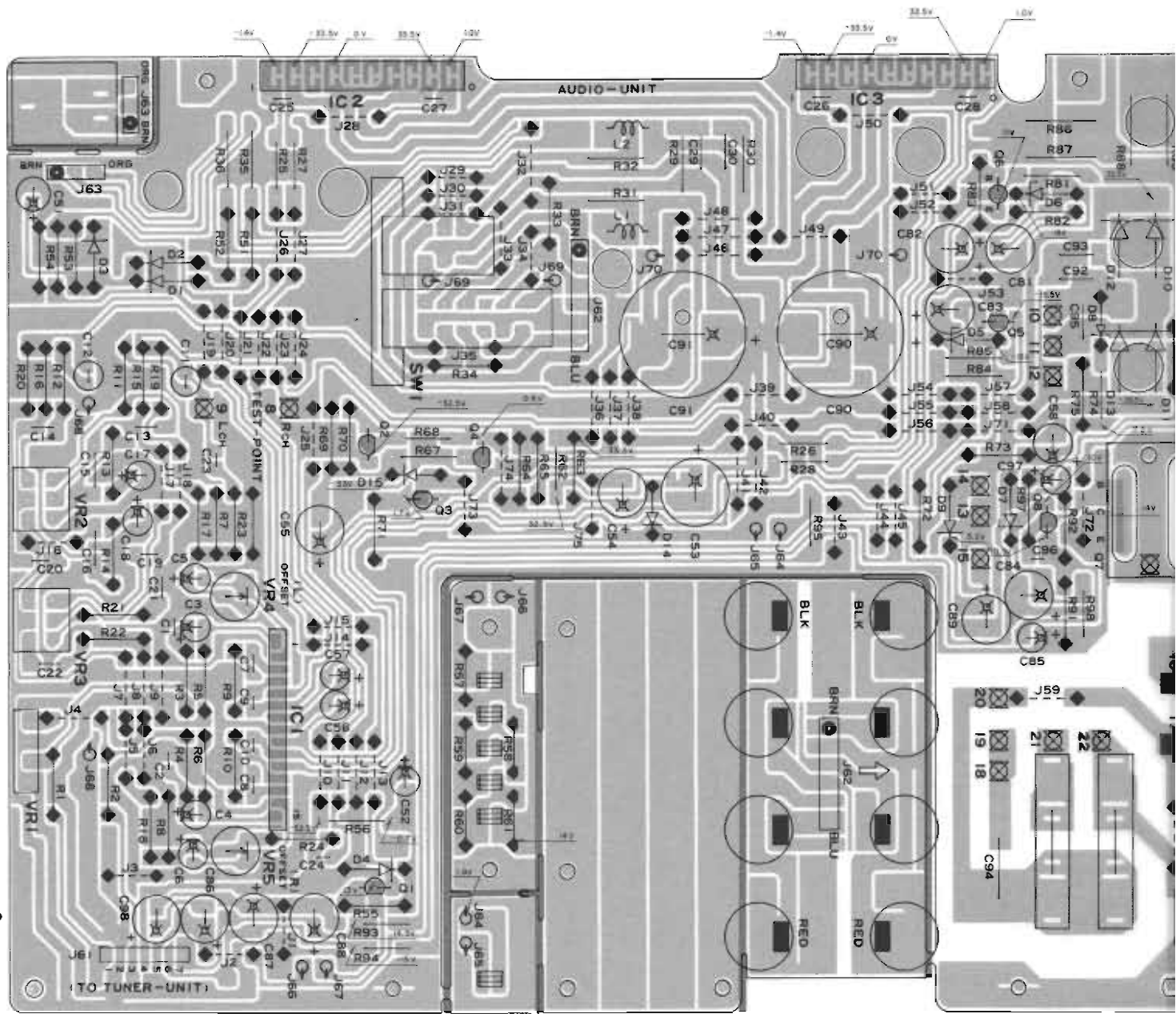

	F 1	F 2	R 96	C 94	C 95
	2.2K(1/4W)	R 0	2.2M	CR-0079-00	R 0
	R 0	(25A)(20M)	R 0	CR-0078-00	R 0
	2.2A	(2A)	R 0	CR-0080-00	R 0
	2.2A(20M)	(25A)(20M)	R 0	CR-0076-00	R 0

2SC1735

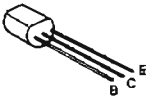

2SA564A 2SC1509
 2SA733(A) 2SC1845
 2SA984K 2SC2320
 2SC945 2SC1923
 2SC828A

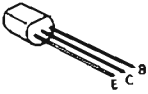

2SC535
 2SC461

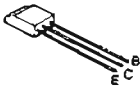

2SK163
 2SK136

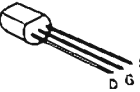

2SK168

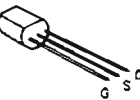

2SD613
 2SD726

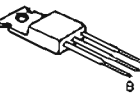

2SC1567

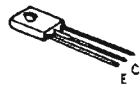

3SK85

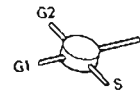

HA1137W
 HA1196
 HA1197

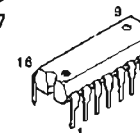

HA1457

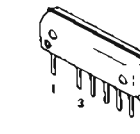

UPC1024H

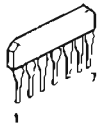

μPD4069

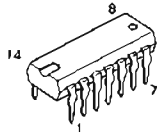

MC14069
 SN74LS90N

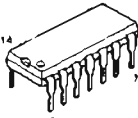

AN6821
 AN6551

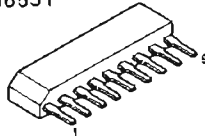

TC4069

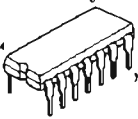

LA5700

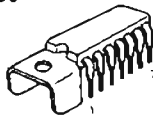

LA1240

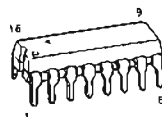

LC7207
 LC7259



SN75154N
 75154PC

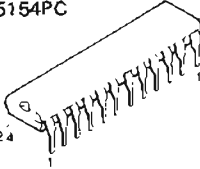

STK1035

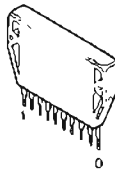

TA1001

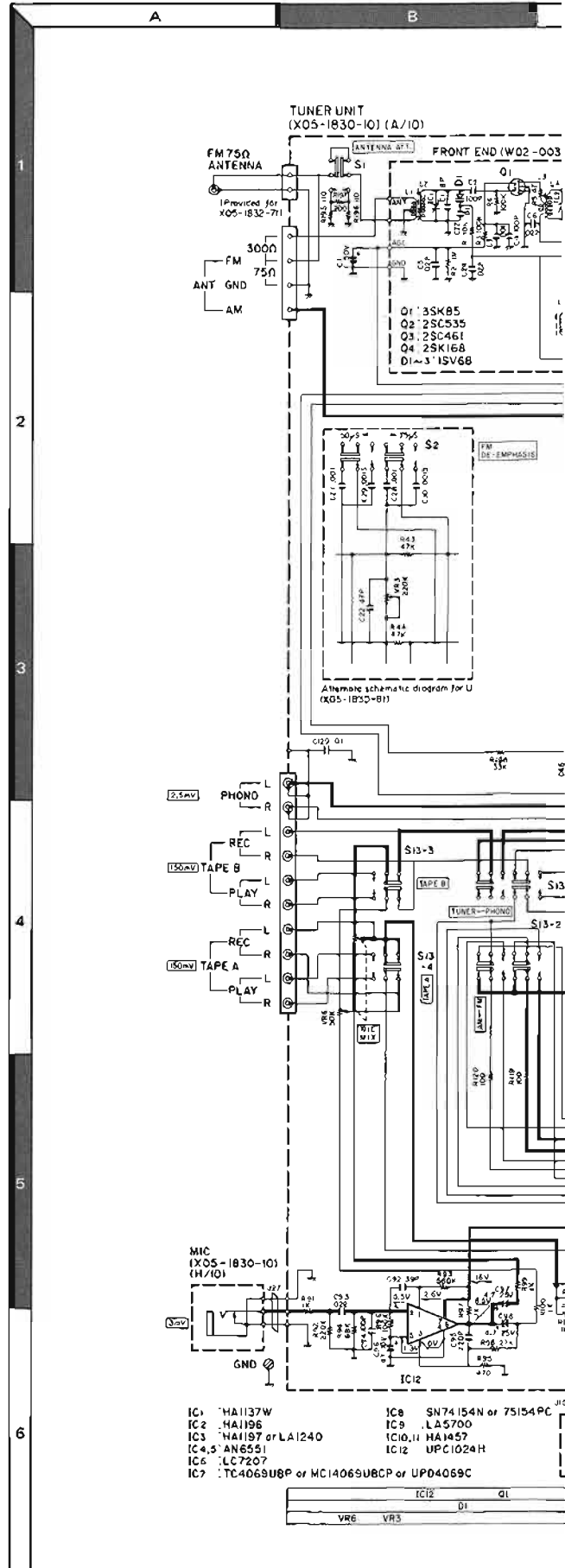
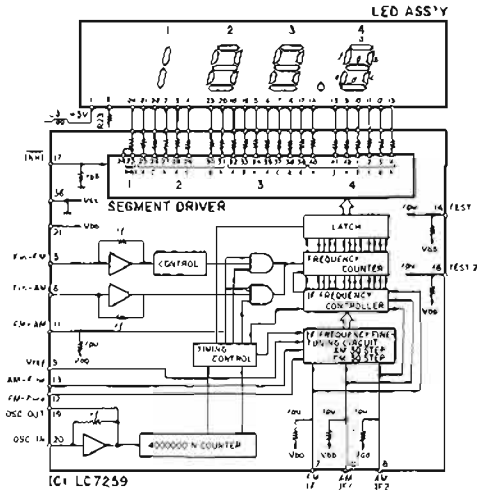
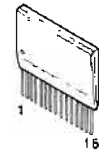

RECEIVER

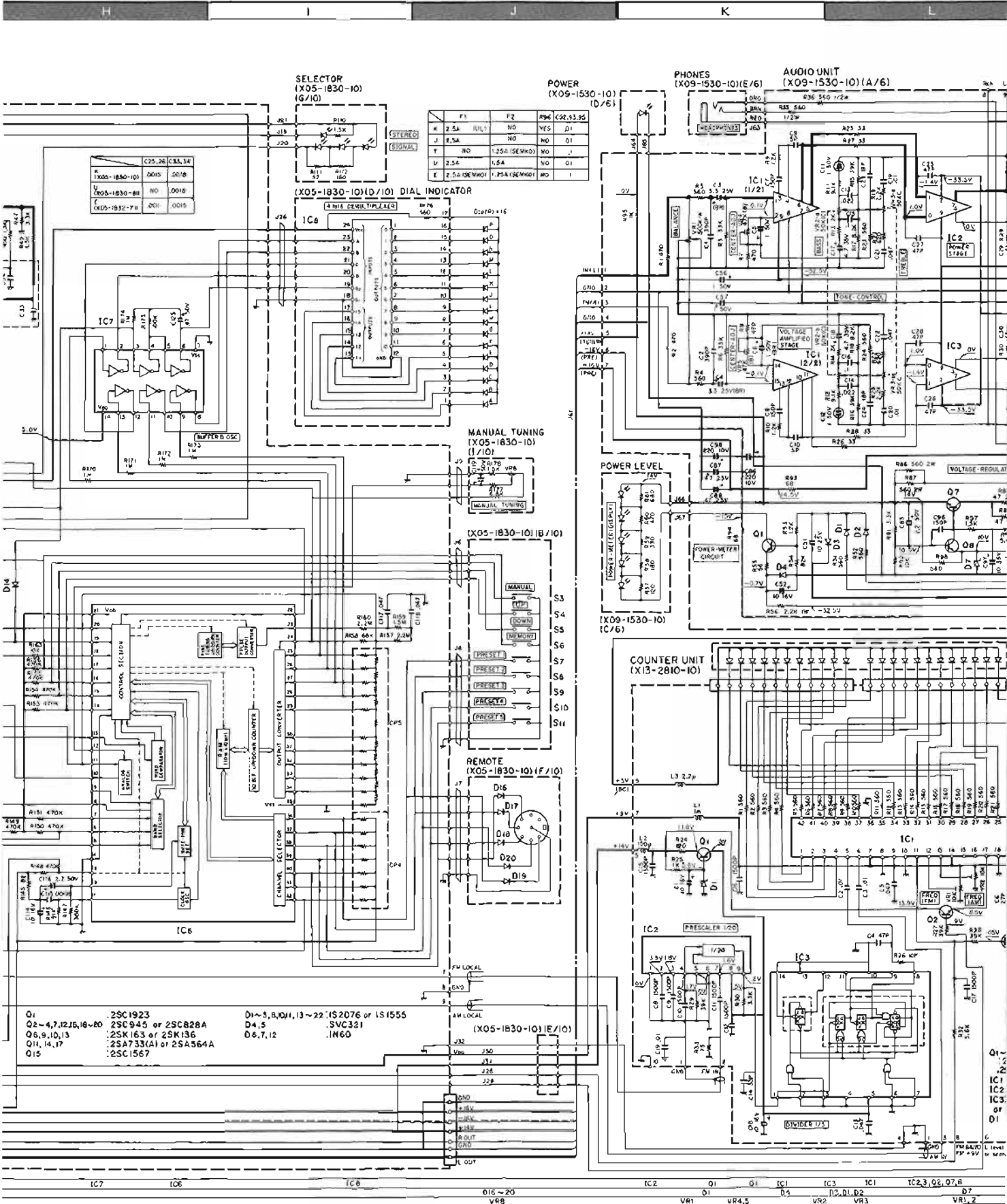

KR-80



SPECIFICATIONS

AUDIO SECTION

Power Output
27 watts* per channel, minimum RMS both channels driven, at 8 ohms from 20 Hz to 20,000 Hz with no more than 0.05% total harmonic distortion.

Both Channels Driven
 Into 8 ohms at 1,000 Hz 31 W - 31 W
 Into 4 ohms at 1,000 Hz 31 W - 31 W
Total Harmonic Distortion (20 Hz to 20 kHz from TAPE)
 rated power into 8 ohms 0.05%
 1 W power into 8 ohms 0.03%
Intermodulation Distortion (60 Hz, 7 kHz = 4:1 SMPTE)
 rated power into 8 ohms 0.02%
Damping Factor 45 at 1 kHz, 8 ohms
Input Sensitivity/Impedance
 PHONO 2.6 mV/50 kohms
 TAPE 150 mV/50 kohms
 MIC 3.0 mV/50 kohms

Signal-to-Noise Ratio (A weighted)
 PHONO 78 dB for 2.5 mV input
 TAPE 84 dB for 5.0 mV input
 MIC 105 dB for 150 mV input
 MIC 72 dB for 3.0 mV input
Maximum Phono Input Level
 at 1,000 Hz 160 mV (RMS), THD 0.05%
Frequency Response
 PHONO RIAA Standard Curve 20 Hz to 20 kHz, +0.3 dB
 TAPE 5 Hz to 130 kHz, -3 dB

Tone Control
 Bass +3 dB at 100 Hz
 Treble +8 dB at 10 kHz
Loudness Control (VOL -30dB) +10 dB at 100 Hz
High Filter 5 kHz, 6 dB/oct
Output Level/Impedance
 TAPE REC Out (Pnt) 150 mV/300 ohms

FM TUNER SECTION

Usable Sensitivity 10.3 dBf (1.8 μ V)
50 dB Quieting Sensitivity
 Mono 16.1 dBf (3.5 μ V)
 Stereo 37.2 dBf (40 μ V)
Signal-to-Noise Ratio at 65 dBf
 Mono 75 dB
 Stereo 70 dB
 Stereo 72 dB (at 85 dBf)
Total Harmonic Distortion at 1 kHz
 Mono 0.1%
 Stereo 0.15%
Frequency Response 30 Hz to 15 kHz, +0.5 dB, -2.0 dB
Capture Ratio 1.0 dB
Image Rejection Ratio 50 dB
Spurious Response Ratio 80 dB
IF Response Ratio 105 dB
Alternate Channel Selectivity 50 dB at 400 kHz
AM Suppression Ratio 80 dB
Stereo Separation Ratio 47 dB at 1,000 Hz
 35 dB at 50 Hz to 10 kHz
Subcarrier Product Ratio 55 dB
Antenna Impedance 300 ohms balanced & 75 ohms unbalanced
FM Frequency Range 88 MHz to 108 MHz

AM TUNER SECTION

Usable Sensitivity 10 μ V
Signal-to-Noise Ratio 50 dB
Image Rejection 35 dB
Selectivity 40 dB

GENERAL

Power Consumption 135 W (8 ohms at rated power)
 22 W (No Signal)
AC Outlets Switched 1, Unswitched 1
Dimensions W 440 mm (17.5/16.7")
 H 78 mm (3.1/3.1")
 D 335 mm (13.2/13.2")
Weight (Net) 6.1 kg (13.4 lb)
 (Gross) 7.0 kg (15.4 lb)

*Measured pursuant to Federal Trade Commission's Trade Regulation rule on Power Output Claims for Amplifier in U.S.A.

Kennwood follows a policy of continuous developments in development. For this reason specifications may be changed without notice.

Kennwood stellt ständige Verbesserungen in der Entwicklung an. Daher dienen Änderungen der technischen Daten jederzeit vorbehalten.

Kennwood poursuit une politique de progrès constants en ce qui concerne le développement. Pour cette raison les spécifications sont sujettes à modifications sans préavis.

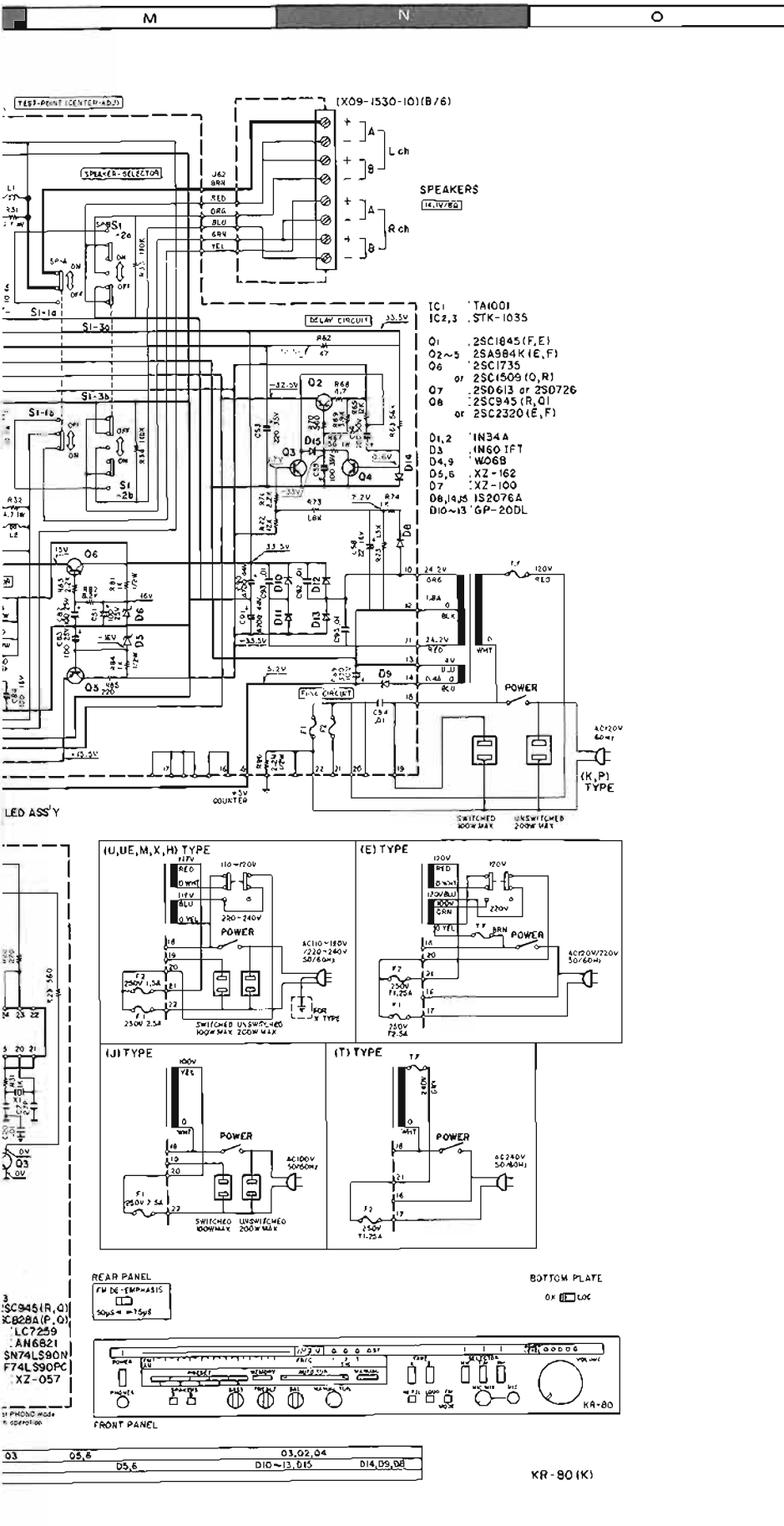

2SC1735

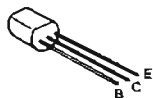

2SA564A 2SC1509
2SA733(A) 2SC1845
2SA984K 2SC2320
2SC945 2SC1923
2SC828A

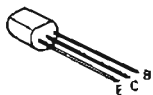

2SC535
2SC461

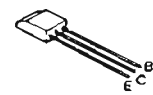

2SK163
2SK136

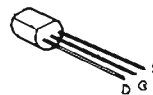

2SK168

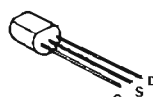

2SD613
2SD726

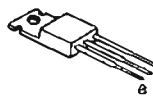

2SC1567

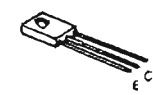

3SK85

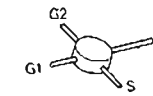

HA1137W
HA1196
HA1197



HA1457

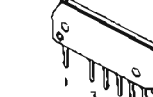

UPC1024H

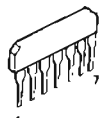

μPD4069

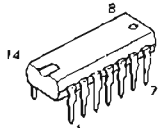

LC7207
LC7259

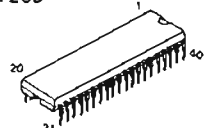

MC14069
SN74LS90N

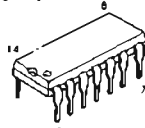

AN6821
AN6551

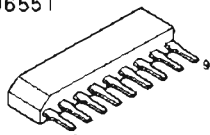

TC4069

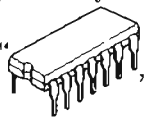

LA5700

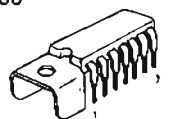

LA1240

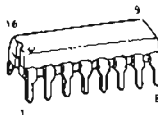

LC7207
LC7259

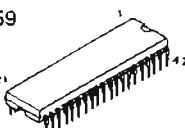

SN75154N
75154PC

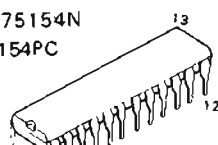

STK1035

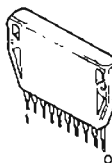

TA1001

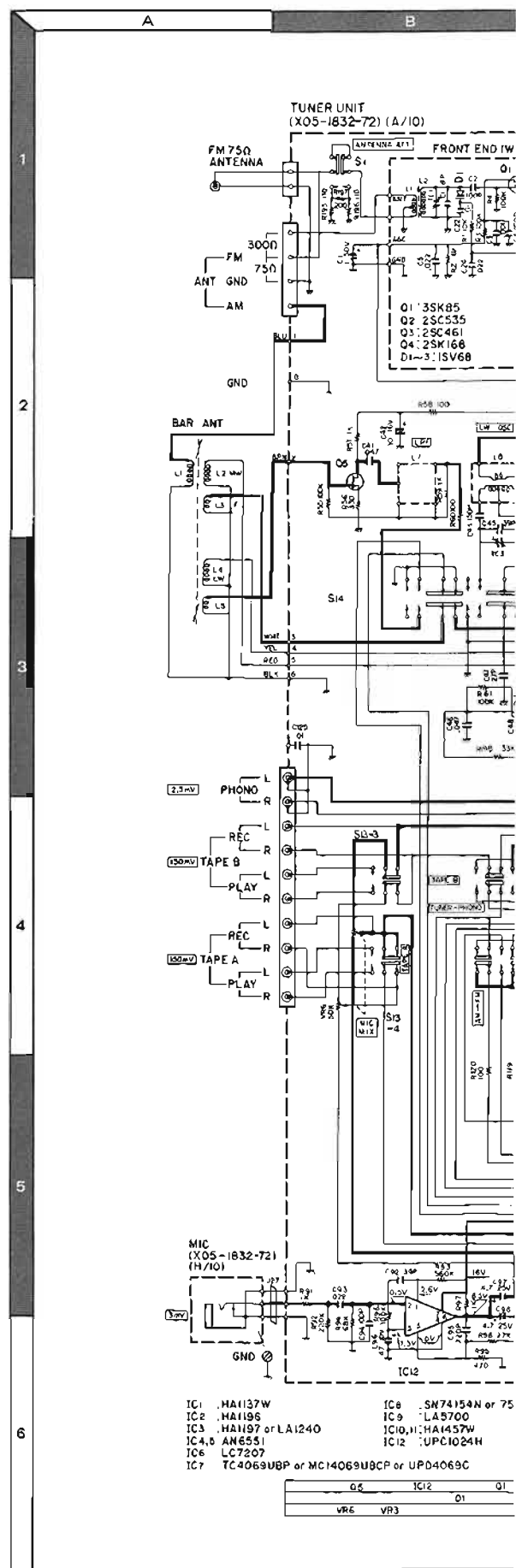
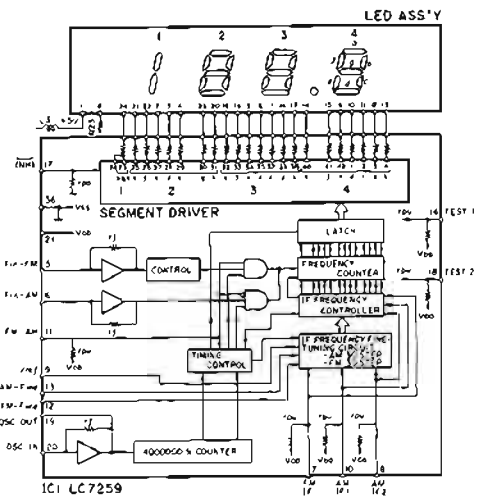
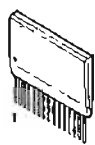

O RECEIVER

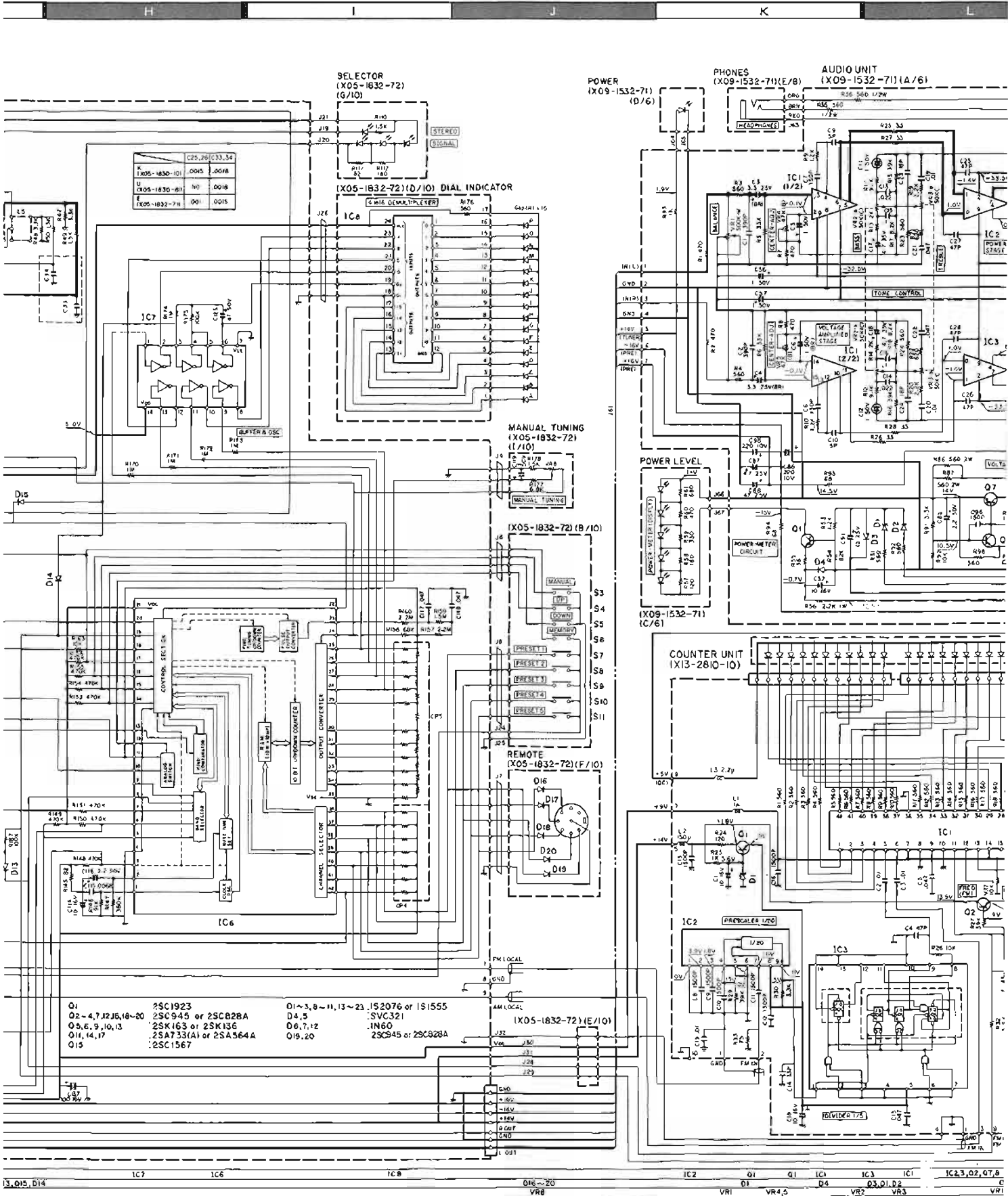

KR-80L



SPECIFICATIONS

AUDIO SECTION

Rated Power Output	
8 ohms at 20 Hz to 20 kHz no more than 0.05% THD (FTC)	27 W - 27 W
4 ohms at 63 Hz to 12.5 kHz no more than 0.7% THD (IEC)	30 W - 30 W
Total Harmonic Distortion	
Rated Power Output into 8 ohms	0.05%
Intermodulation Distortion	0.02%
Frequency Response	±0.5 dB - 3 dB

S/N Weighted, Rated Output Power (IEC-A)

(1) - Unweighted at 50 mW (DIN)	
Phono	78 dB (58 dB)
Tuner, Tape	105 dB (60 dB)
Damping Factor at 8 ohms, 1 kHz	45
Input Sensitivity/Impedance	
Phono	2.5 mV/50 kΩ
Tuner, Tape	150 mV/50 kΩ
Tone Control	
Bass 100 Hz	±8 dB
Treble 10 kHz	±8 dB
Loudness Control (-30 dB)	100 Hz - 10 dB
High Filter	5 kHz 6 dB/oct

FM TUNER SECTION

Sensitivity at 75 ohms	
Mono: S/N 28 dB 40 kHz Dev	0.7 μV
Stereo: S/N 46 dB 46 kHz Dev	25 μV
50 dB Quieting Sensitivity Mono (HF)	3.5 μV
Limiting Level	
-3 dB Point, 40 kHz Dev	0.4 V
Frequency Response	
	±0.5 dB - 2 dB

Total Harmonic Distortion	
Mono: 1 kHz 40 kHz Dev	0.09%
Stereo: 1 kHz, 46 kHz Dev	0.2%

S/N Weighted (IEC A)	
Mono: 40 kHz Dev, 1 mV Input	70 dB
Stereo: 46 kHz Dev, 1 mV Input	65 dB

S/N Ratio (IHF)	
Mono: 75 kHz Dev, 1 mV Input	75 dB
Stereo: 75 kHz Dev, 1 mV Input	70 dB

FM Stereo Separation: 1 mV Input (DIN)	
250 Hz	37 dB
1 kHz	45 dB
6.3 kHz	30 dB
12.5 kHz	22 dB
Image Rejection Ratio	
Selectivity	50 dB

300 kHz, 20 dB Input	75 dB
IF Rejection Ratio	
	105 dB
AM Suppression Ratio	
	60 dB
Spurious Response Ratio	
	80 dB
Capture Ratio	
	1.0 dB
Pilot Tone 19 kHz	
	55 dB

MW TUNER SECTION

Sensitivity S/N 20 dB	10 μV
S/N Ratio 1 mV Input	50 dB
Image Rejection Ratio	35 dB

LW TUNER SECTION

Sensitivity S/N 20 dB	15 μV
S/N Ratio: 1 mV Input	50 dB
Image Rejection Ratio	58 dB

GENERAL

Power Consumption	
Rated Power at 8 ohms	135 W
No signal	22 W
Dimensions	
W	440 mm
H	78 mm
D	336 mm
Weight (Net)	
	6.1 kg

Klipschall follows a policy of continuous advancements in development for this reason specifications may be changed without notice.

Klipschall akzeptiert stetige Verbesserungen in der Entwicklung an. Daher bleiben Änderungen der technischen Daten jederzeit vorbehalten.

Klipschall poursuit une politique de progrès constants en ce qui concerne le développement. Pour cette raison les spécifications sont sujettes à modifications sans préavis.

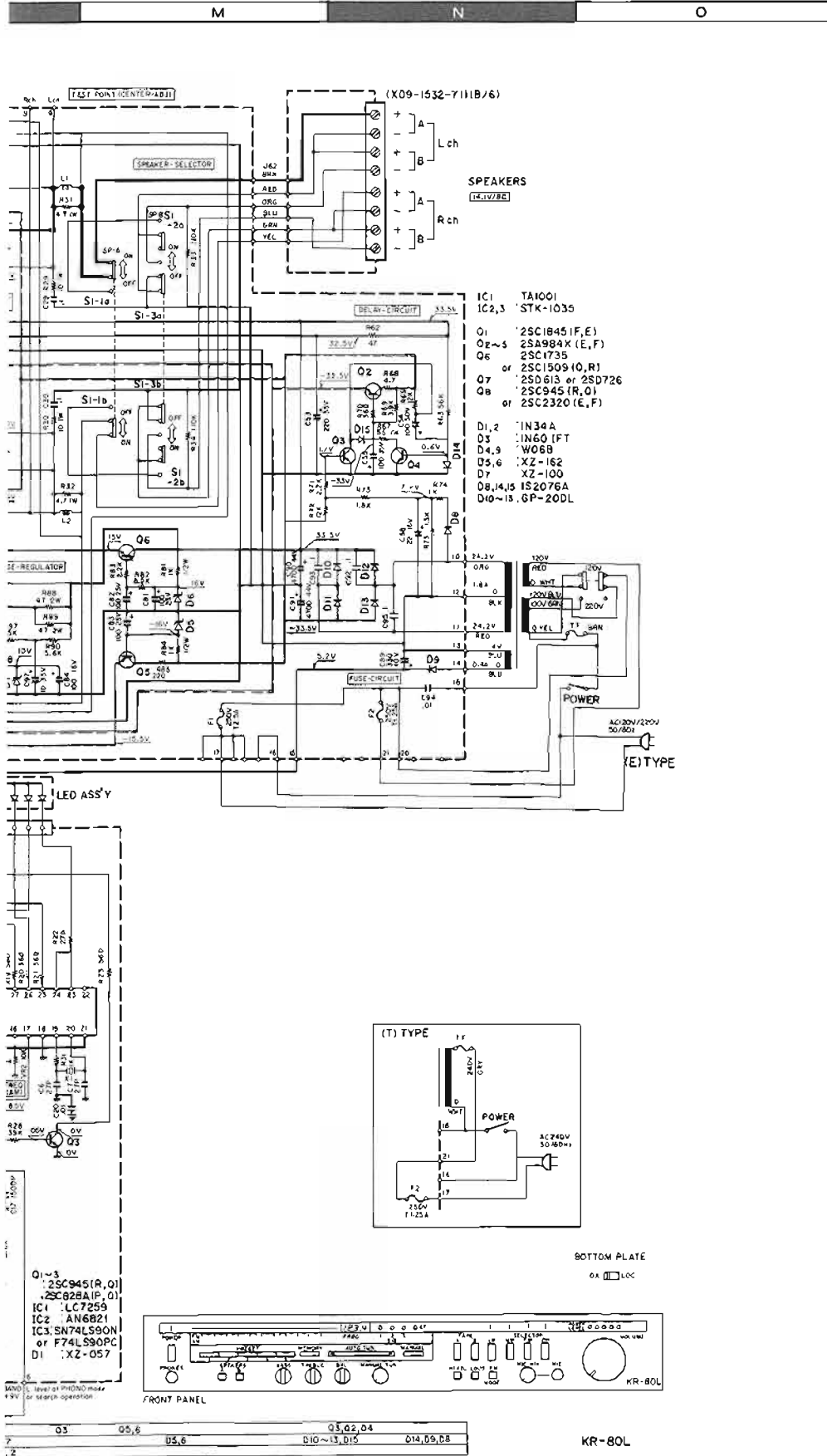

PARTS LIST

INSTRUCTION FOR PARTS LIST

Ref. No. 参照番号	Parts No. 部品番号	Description 部品名 / 規格	Re- marks 備考
②	18 1A	A01-0608-12 METALLIC CABINET	* ③
①	19 2A	A20-1979-11 FRCNT PANEL ASSY	*K ④
	19 2A	A20-1979-11 FRCNT PANEL ASSY	PU
	19 2A	A20-1979-11 FRCNT PANEL ASSY	MH
	19 2A	A20-1979-11 FRCNT PANEL ASSY	XE
	19 2A	A20-1979-11 FRCNT PANEL ASSY	⑤
	R221	043-1333-15 FL-PROOF RD330 J 2K	*
	R222	R43-1368-15 FL-PROOF RD680 J 2K	*
	VR1 ,2	R12-3301-05 TRIMMING POT. 20K(B)	*
	VR3 ,4	R16-6305-05 POTENTIOMETER (OUTPUT)	*
	VR5 ,6	R12-2302-05 TRIMMING POT. 5K(B)	*

- ① Exploded view drawing No
 ② Position in exploded view
 ③ Symbol of new parts
 ④ Area to which parts are shipped Example A20-1979-11 is the part No. of FRONT PANEL ASSY for the 'K' type products (for USA) When this column is blank it means that the same type of parts (same parts No.) are used for the products shipped to all areas
 ⑤ Reference No. in schematic diagram.
 ⑥ Abbreviation of ceramic capacitor
 All capacitors and resistors are listed using abbreviations
 Abbreviations
- * Abbreviations of capacitors (Parts No. with initial letter "C")
 - ELECTRO Electrolytic capacitor
 - LL-ELEC Low leak electrolytic capacitor
 - NP-ELEC Non-pole electrolytic capacitor
 - MICA Mica capacitor
 - POLYSTY Polystyrene capacitor
 - MYLAR Mylar capacitor
 - CERAMIC Ceramic capacitor
 - TANTAL Tantalum capacitor
 - MF Metallized film capacitor
 - MP Metallized paper capacitor
 - OIL Oil capacitor
 - The unit "UF" is used in lieu of "μF"
 - * Abbreviations of resistors (Parts No. with initial letters "R")
 - RC Carbon composition resistor
 - RD Carbon film resistor
 - FL-PROOF RD Flame-proof carbon film resistor
 - RW Wire wound power resistor
 - FL-PROOF RS Flame-proof metal oxide film resistor
 - RN Metal film resistor
 - FUSE-RESIST Resistor with fuse function
 - 2B Rated wattage 1/8W
 - 2E Rated wattage 1/4W
 - 2H Rated wattage 1/2W
 - 3A Rated wattage 1W
 - 3D Rated wattage 2W
 - 3F Rated wattage 3W
 - 3G Rated wattage 4W
 - 3H Rated wattage 5W
 - All resistor values are indicated with the unit (Ω) omitted
 - * Abbreviations common to capacitors and resistors
 - C ±0.25pF (Used for capacitors only)
 - D ±0.5pF (Used for capacitors only)
 - F ±1%
 - G ±2%
 - J ±5%
 - K ±10%
 - M ±20%
 - Z +80% -20%(Used for capacitors only)
 - P +100% -0%(Used for capacitors only)
 - Resistors RD (carbon composition resistors) are not listed in the parts list. For values refer to the schematic diagram.

- * Codes in X05-1530-10
 - K: X05-1530-10
 - U: X05-1530-81
 - E: X05-1532-71
 - Ⓛ: X05-1532-72
- * Codes in X09-1530-10
 - K: X09-1530-10
 - T: X09-1530-51
 - U: X09-1530-81
 - E: X09-1532-71

Ref. No. 参照番号	Parts No. 部品番号	Description 部品名 / 規格	Re- marks 備考
KR-80, 80L (UNIT)			
1	2A	-	
2	1P	-	
3	3B	-	
4	2B	-	
5	2B	-	
6	2B	-	
10	1A	A01-0385-03 METALLIC CABINET	
11	3A	A20-1631-03 FRONT PANEL	*K
11	3A	A20-1631-03 FRCNT PANEL	PU
11	3A	A20-1631-03 FRCNT PANEL	MH
11	3A	A20-1631-03 FRONT PANEL	XE
11	3A	A20-1631-03 FRCNT PANEL	Ⓛ
11	3A	A20-1633-03 FRONT PANEL	*T
11	3A	A20-1634-03 FRONT PANEL	Ⓛ
11	3A	A20-1635-03 FRCNT PANEL	*L
-	-	B46-0055-20 WARRANTY CARD	P
-	-	B46-0060-00 WARRANTY CARD	T
-	-	B46-0061-20 WARRANTY CARD	K
-	-	B46-0062-20 WARRANTY CARD	UH
-	-	B46-0063-13 WARRANTY CARD	UH
-	-	B46-0064-10 WARRANTY CARD	X
-	-	B50-313E-00 INSTRUCTION MANUAL	*K
-	-	B50-313E-00 INSTRUCTION MANUAL	PU
-	-	B50-313E-00 INSTRUCTION MANUAL	MH
-	-	B50-313E-00 INSTRUCTION MANUAL	X
-	-	B50-313E-00 INSTRUCTION MANUAL	Ⓛ
-	-	B50-3140-00 INSTRUCTION MANUAL	*P
-	-	B50-3140-00 INSTRUCTION MANUAL	MX
-	-	B50-3141-00 INSTRUCTION MANUAL	*T
-	-	B50-3142-00 INSTRUCTION MANUAL	*E
-	-	B50-3143-00 INSTRUCTION MANUAL	*E
-	-	B50-3144-00 INSTRUCTION MANUAL	Ⓛ
-	-	B50-3185-00 INSTRUCTION MANUAL	*E
12	3A	B10-0269-04 FRCNT GLASS	*K
12	3A	B10-0269-04 FRCNT GLASS	PU
12	3A	B10-0269-04 FRCNT GLASS	MH
12	3A	B10-0269-04 FRCNT GLASS	XE
12	3A	B10-0269-04 FRCNT GLASS	Ⓛ
12	3A	B10-0271-04 FRCNT GLASS	T
12	3A	B10-0271-04 FRCNT GLASS	*T
12	3A	B10-0271-04 FRCNT GLASS	Ⓛ
13	3A	B20-0470-03 DIAL CALIBRATIONS	*K
13	3A	B20-0470-03 DIAL CALIBRATIONS	PU
13	3A	B20-0470-03 DIAL CALIBRATIONS	MH
13	3A	B20-0470-03 DIAL CALIBRATIONS	XE
13	3A	B20-0470-03 DIAL CALIBRATIONS	Ⓛ
13	3A	B20-0470-03 DIAL CALIBRATIONS	T
13	3A	B20-0472-03 DIAL CALIBRATIONS	*T
13	3A	B20-0472-03 DIAL CALIBRATIONS	Ⓛ
14	2A	B38-0015-05 DISPLAY ASSY	*
15	1B	E03-0023-05 AC OUTLET	*K
15	1B	E03-0023-05 AC OUTLET	UM
15	1B	E03-0023-05 AC OUTLET	HX
15	1B	E03-0023-05 AC OUTLET	Ⓛ
15	1B	E03-0024-05 AC OUTLET	*P
16	1B	E04-0004-05 RECEPTACLE	TE
16	1B	E04-0004-05 RECEPTACLE	Ⓛ
17	1B	E30-0181-05 POWER CORD	KP
17	1B	E30-0185-05 POWER CORD	X
17	1B	E30-0459-05 POWER CORD	Ⓛ

PARTS LIST

Ref. No. 参照番号	Parts No. 部品番号	Description 部品名 / 规格	Re- marks 備考
17 1B	E30-0545-05	POWER CORD	UM
17 1B	E30-0545-05	POWER CORD	UE
17 1B	E30-0545-05	POWER CORD	H
17 1B	E30-0587-05	POWER CORD	YI
-	H01-3175-04	CARTON BOX	*K
-	H01-3175-04	CARTON BOX	PL
-	H01-3175-04	CARTON BOX	MH
-	H01-3175-04	CARTON BOX	UE
-	H01-3175-04	CARTON BOX	X
-	H01-3178-04	CARTON BOX	*E
-	H01-3180-04	CARTON BOX	*E
-	H01-3181-04	CARTON BOX	*T
-	H01-3181-04	CARTON BOX	T
-	H10-1553-03	POLYSTYRENE FIXTURE	
-	H25-0078-04	BAG	
-	H25-0179-04	BAG	
-	H39-0018-05	PACKING PARTS	
-	J61-0045-05	WIRE BAND	
18 3A, 3B	J02-0109-05	FOOT X4	
19A 1B	J19-0507-05	HOLDER	YE
19B 1B	J19-0564-05	HOLDER	KP
19B 1B	J19-0564-05	HOLDER	UM
19B 1B	J19-0564-05	HOLDER	HX
19B 1B	J19-0564-05	HOLDER	TE
19B 1B	J19-0564-05	HOLDER	UE
20 1B	J41-0034-05	BUSHING	KP
20 1B	J42-0084-05	BUSHING	UM
20 1B	J42-0084-05	BUSHING	HT
20 1B	J42-0084-05	BUSHING	ET
20 1B	J42-0084-05	BUSHING	YI
20 1B	J42-0084-05	BUSHING	E
20 1B	J42-0085-05	BUSHING	X
21 3B	K27-0148-04	KNOB X3	*
22 2A	K27-0149-04	KNOB X2	*
23 3B	K27-0151-04	KNOB X5	*K
23 3B	K27-0151-04	KNOB X5	PU
23 3B	K27-0151-04	KNOB X5	MH
23 3B	K27-0151-04	KNOB X5	X
23 3B	K27-0151-04	KNOB X5	XT
23 3B	K27-0151-04	KNOB X5	VE
23 3B	K27-0151-04	KNOB X5	E
23 3B	K27-0151-04	KNOB X5	*T
23 3B	K27-0151-04	KNOB X5	E
24 2A	K27-0176-04	KNOB	*
25 3A	K29-0346-02	KNOB ASSY	*
26 3A	K29-0349-04	KNOB	*
27 3A	K29-0376-04	KNOB X3	*
28 2A	K29-0377-04	KNOB X2	*
29 3B	L01-2071-05	POWER TRANSFORMER	*X
29 3B	L01-2072-05	POWER TRANSFORMER	*T
29 3B	L01-2072-05	POWER TRANSFORMER	T
29 3B	L01-2075-05	POWER TRANSFORMER	*U
29 3B	L01-2075-05	POWER TRANSFORMER	MH
29 3B	L01-2075-05	POWER TRANSFORMER	UE
29 3B	L01-2075-05	POWER TRANSFORMER	X
29 3B	L01-2076-05	POWER TRANSFORMER	*E
29 3B	L01-2076-05	POWER TRANSFORMER	E
29 3B	L01-2077-05	POWER TRANSFORMER	*P
30 1B	N08-0128-05	DRESS SCREW	
31 1B	N09-0303-05	SCREW X2	
32 2A	N29-0035-05	PUSH RIVET X2	
38 1B	S31-2050-05	SLIDE SWITCH	UM

Ref. No. 参照番号	Parts No. 部品番号	Description 部品名 / 规格	Re- marks 備考
38 1B	S31-2050-05	SLIDE SWITCH	KX
38 1B	S31-2050-05	SLIDE SWITCH	E
38 1B	S31-2050-05	SLIDE SWITCH	UE
39 1A	S40-1022-05	PUSH SWITCH	UM
39 1A	S40-1022-05	PUSH SWITCH	HX
39 1A	S40-1022-05	PUSH SWITCH	UE
39 1A	S40-1024-05	PUSH SWITCH	*K
39 1A	S40-1024-05	PUSH SWITCH	P
39 1A	S40-1025-05	PUSH SWITCH	*T
39 1A	S40-1025-05	PUSH SWITCH	ET
39 1A	S40-1025-05	PUSH SWITCH	E
-	T90-0202-05	ANTENNA (FM)	
40 1B	T90-0104-05	ANTENNA (AM LOOP)	KP
40 1B	T90-0104-05	ANTENNA (AM LOOP)	UM
40 1B	T90-0104-05	ANTENNA (AM LOOP)	HX
40 1B	T90-0104-05	ANTENNA (AM LOOP)	TE
40 1B	T90-0104-05	ANTENNA (AM LOOP)	UE
41 1B	T90-0107-05	ANTENNA (AM BAR)	*T
41 1B	T90-0107-05	ANTENNA (AM BAR)	E
42 2B	X05-1830-10	TUNER PCB ASSY	*K
42 2B	X05-1830-10	TUNER PCB ASSY	F
42 2B	X05-1830-81	TUNER PCB ASSY	*U
42 2B	X05-1830-81	TUNER PCB ASSY	MH
42 2B	X05-1830-81	TUNER PCB ASSY	X
42 2B	X05-1832-71	TUNER PCB ASSY	*T
42 2B	X05-1832-71	TUNER PCB ASSY	E
42 2B	X05-1832-72	TUNER PCB ASSY	*T
42 2B	X05-1832-72	TUNER PCB ASSY	E
43 2B	X09-1530-10	AUDIO AMP PCB ASSY	*X
43 2B	X09-1530-10	AUDIO AMP PCB ASSY	P
43 2B	X09-1530-51	AUDIO AMP PCB ASSY	*T
43 2B	X09-1530-51	AUDIO AMP PCB ASSY	T
43 2B	X09-1530-81	AUDIO AMP PCB ASSY	*U
43 2B	X09-1530-81	AUDIO AMP PCB ASSY	MH
43 2B	X09-1530-81	AUDIO AMP PCB ASSY	UE
43 2B	X09-1530-81	AUDIO AMP PCB ASSY	X
43 2B	X09-1532-71	AUDIO AMP PCB ASSY	*E
43 2B	X09-1532-71	AUDIO AMP PCB ASSY	E
44 2B	X13-2810-10	FREQ COUNTER PCB ASSY	*
TUNER (X05-1530-10, 81, X05-1532-71, 72)			
102 2A	B38-0012-05	DISPLAY ASSY	*
103 2A	B38-0018-05	DISPLAY ASSY	*
024	B30-0230-05	LED	E
C1	C24-1710-51	ELECTRO 1UF 50WV	
C2	C24-1747-41	ELECTRO 0.47UF 50WV	
C3 -6	C55-1710-38	CERAMIC 0.01UF Z	
C7	C52-1733-16	CERAMIC 330PF K	
C8	C24-1747-41	ELECTRO 0.47UF 50WV	
C9 ,10	C55-1710-38	CERAMIC 0.01UF Z	
C11 ,12	C55-1747-38	CERAMIC 0.047UF Z	
C13 ,14	C24-1210-61	ELECTRO 10UF 16WV	E
C15	C24-1710-51	ELECTRO 1UF 50WV	
C16	C52-1768-16	CERAMIC 680PF K	
C17	C48-1736-15	POLYSTY 360PF J	
C18	C24-1722-51	ELECTRO 2.2UF 50WV	
C19	C24-1733-51	ELECTRO 3.3UF 50WV	
C20	C24-1747-41	ELECTRO 0.47UF 50WV	
C21	C24-1247-71	ELECTRO 470UF 16WV	
C22	C71-1747-05	CERAMIC 47PF J	
C23 ,24	C24-1447-51	ELECTRO 4.7UF 25WV	
C25 ,26	C46-1710-25	MYLAR 0.001UF J	E

PARTS LIST

Ref. No. 参照番号	Parts No. 部品番号	Description 部品名 / 規格	Re- marks 備考
C25 ,26	C46-1715-25	MYLAR 0.0015UF J	K
C27 ,28	C46-1710-25	MYLAR 0.001UF J	U
C29 ,30	C46-1715-25	MYLAR 0.0015UF J	U
C31 ,32	C24-1710-51	ELECTRO 1UF 50LV	
C33 ,34	C46-1715-25	MYLAR 0.0015UF J	EE
C33 ,34	C46-1718-25	MYLAR 0.0018UF J	KU
C35	C24-1210-71	ELECTRO 100UF 16WV	
C36	C24-1710-51	ELECTRO 1UF 50WV	
C37	C46-1747-35	MYLAR 0.047UF K	
C40 ,41	C46-1747-35	MYLAR 0.047UF K	E
C42	C24-1210-61	ELECTRO 10UF 16WV	E
C43	C47-1715-15	POLYSTY 150PF J	L
C44	C48-1736-15	POLYSTY 360PF J	KU
C44	C48-1736-15	POLYSTY 360PF J	E
C44	C48-1743-15	POLYSTYRENE CAPACITOR	E
C45	C71-1739-06	CERAMIC 39PF J	E
C46	C91-0119-05	CERAMIC 0.047UF K	
C47	C71-1727-06	CERAMIC 27PF J	E
C48	C91-0333-05	CERAMIC 0.01UF M	
C49	C71-1722-06	CERAMIC 22PF J	
C50 -53	C91-0333-05	CERAMIC 0.01UF M	
C54	C52-1710-26	CERAMIC 0.001UF K	
C55	C55-1747-38	CERAMIC 0.047UF Z	
C56	C91-0333-05	CERAMIC 0.01UF M	
C57	C71-1747-05	CERAMIC 47PF J	
C58	C52-1710-26	CERAMIC 0.001UF K	
C59	C24-1710-51	ELECTRO 1UF 50WV	
C60	C24-1210-61	ELECTRO 10UF 16WV	
C61 ,62	C91-0333-05	CERAMIC 0.01UF M	
C63	C46-1747-35	MYLAR 0.047UF K	
C64	C24-1210-61	ELECTRO 10UF 16WV	
C65	C24-1210-71	ELECTRO 100UF 16WV	
C66	C46-1747-35	MYLAR 0.047UF X	
C67	C91-0119-05	CERAMIC 0.047UF X	
C68 -70	C91-0333-05	CERAMIC 0.01UF M	
C75 ,76	C24-1722-51	ELECTRO 2.2UF 50WV	
C77 ,78	C46-1733-25	MYLAR 0.0033UF J	
C79 ,80	C46-1712-35	MYLAR 0.012UF J	
C81 ,82	C71-1727-06	CERAMIC 27PF J	
C83 ,84	C71-1710-15	CERAMIC 100PF J	
C85 ,86	C25-1733-57	LL-ELEC 3.3UF 25WV	
C87 ,88	C71-1710-15	CERAMIC 100PF J	
C89 ,90	C24-1010-71	ELECTRO 100UF 10WV	
C92	C71-1739-06	CERAMIC 39PF J	
C93	C46-1722-35	MYLAR 0.022UF K	
C94	C71-1710-15	CERAMIC 100PF J	
C95	C71-1722-15	CERAMIC 220PF J	
C96	C24-1047-61	ELECTRO 47UF 10WV	
C97 ,98	C24-1447-51	ELECTRO 4.7UF 25WV	
C99 ,100	C46-1768-25	MYLAR 0.0068UF K	
C101,102	C46-1722-35	MYLAR 0.022UF K	
C105-108	C24-1210-61	ELECTRO 10UF 16WV	
C109	C71-1747-05	CERAMIC 47PF J	
C110	C24-1710-51	ELECTRO 1UF 50WV	
C111	C24-1210-61	ELECTRO 10UF 16WV	
C112	C24-1022-61	ELECTRO 22UF 10WV	
C114	C24-1210-61	ELECTRO 10UF 16WV	
C115	C46-1768-25	MYLAR 0.0068UF K	
C116	C24-1722-51	ELECTRO 2.2UF 50WV	
C117,118	C91-0119-05	CERAMIC 0.047UF K	
C119	C24-1710-51	ELECTRO 1UF 50WV	
C120	C46-1722-25	MYLAR 0.0022UF K	

Ref. No. 参照番号	Parts No. 部品番号	Description 部品名 / 規格	Re- marks 備考
C121	C46-1710-35	MYLAR 0.01UF K	
C122	C46-1747-35	MYLAR 0.047UF K	
C125	C24-1747-41	ELECTRO 0.47UF 50WV	
C126	C24-1210-61	ELECTRO 10UF 16WV	
C128	C46-1733-45	MYLAR 0.33UF M	
C129	C55-1710-38	CERAMIC 0.01UF Z	
C130-132	C91-0119-05	CERAMIC 0.047UF K	
C133	C24-1210-61	ELECTRO 10UF 16WV	
C134	C46-1710-35	MYLAR 0.01UF K	
C135	C24-1710-51	ELECTRO 1UF 50WV	
C136	C24-1210-61	ELECTRO 10UF 16WV	
C137	C24-1210-71	ELECTRO 100UF 16WV	E
TC1	C05-0303-05	TRIMMER CAPACITOR 20P	E
TC2	C05-0301-05	TRIMMER CAPACITOR 7P	E
TC2	C05-0303-05	TRIMMER CAPACITOR 20P	KU
TC2	C05-0303-05	TRIMMER CAPACITOR 20P	E
TC3 ,4	C05-0303-05	TRIMMER CAPACITOR 20P	E
104 1B	E06-0801-05	DIN CONNECTOR	
105 2A	E11-0078-05	PHCNE JACK 2P	*
106 2B	E13-0423-05	PHONO JACK 4P	
107 2B	E13-0612-05	PHONO JACK 6P	
108 2B	E20-0439-05	TERMINAL BOARD 4P	
CF1 ,2	L72-0052-15	CERAMIC FILTER	KU
CF1 ,2	L79-0123-05	FILTER	E
CF3	L72-0078-05	CERAMIC FILTER	
L1	L40-2292-11	INDUCTOR 2.2UH	
L2	L30-0323-05	IFT FM	
L3	L30-0324-05	IFT FM	
L4	L79-0109-05	LPF	E
L5	L79-0127-05	LPF	*
L6	L31-0455-05	RF COIL MW	*K
L6	L31-0455-05	RF COIL MW	UE
L7	L79-0119-05	LPF	E
L8	L32-0240-05	OSCILLATING COIL LW	E
L9	L32-0239-05	OSCILLATING COIL MW	*A
L9	L32-0239-05	OSCILLATING COIL MW	UE
L9	L32-0243-05	OSCILLATING COIL LW	E
L10	L30-0329-05	IFT AM	
L11	L30-0284-05	IFT AM	
L12	L30-0350-05	IFT AM	*
L13	L30-0351-05	IFT AM	*
L14	L40-1021-45	INDUCTOR 1MH	KU
L14	L40-1021-45	INDUCTOR 1MH	E
L14	L40-1031-05	INDUCTOR 10MH	E
L15	L79-0127-05	LPF	*
-	R90-0137-05	MULTIPLE COMPONENTS	*
R4+C2	R90-0134-05	MULTIPLE COMPONENTS	*
R4+C1+J1	R90-0135-05	MULTIPLE COMPONENTS	*
R5+C1+J1	R90-0136-05	MULTIPLE COMPONENTS	*
R7+J1	R90-0132-05	MULTIPLE COMPONENTS	*
R24	R43-1210-15	FL-PROOF RD100 J 2E	
R33	R43-1256-05	FL-PROOF RD56 J 2E	
R72	R43-1210-15	FL-PROOF RD100 J 2E	
R19S	R40-8310-16	RC 100 J 2E	K
VR1 ,2	R12-3045-05	TRIMMING POT. 10K	
VR3	R12-3046-05	TRIMMING POT. 47K	EE
VR3	R12-5031-05	TRIMMING POT. 220K	KU
VR4	R12-3045-05	TRIMMING POT. 10K	
VR5	R12-1038-05	TRIMMING POT. 1K	
VR6	R10-4003-05	POTENTIOMETER	109 *
VR7	R06-5054-05	POTENTIOMETER	110 *

PARTS LIST

Ref. No. 参照番号	Parts No. 部品番号	Description 部品名 / 规格	Re- marks 備考
VR8	R29-3002-05	POTENTIOMETER 111	*
-	S90-0036-05	REMOTE WIRE	E
S1	S31-2052-05	SLIDE SWITCH ANT ATT	*
S2	S31-4010-05	SLIDE SWITCH EMPHASIS	U
S3 -11	S40-1023-05	PUSH SWITCH 115	*
S12	S42-3039-05	PUSH SWITCH 3KEY 116	*
S13	S42-5017-05	PUSH SWITCH 5KEY 117	*K
S13	S42-5017-05	PUSH SWITCH 5KEY 117	UE
S13	S42-6007-05	PUSH SWITCH 6KEY 117	E
S14	S90-0035-05	SLID SWITCH	E
D1 -3	V11-0271-05	1S2076,1S1555	*
D4 ,5	V11-6101-00	SVC321-2(A,B)	*K
D4 ,5	V11-6101-00	SVC321-2(C)	E
D4 ,5	V11-6101-00	SVC321-2(A,B)	UE
D6 ,7	V11-0051-05	1N60	
D8 ,9	V11-0271-05	1S2076,1S1555	E
D8	V11-0271-05	1S2076,1S1555	
D10 ,11	V11-0271-05	1S2076,1S1555	
D12	V11-0051-05	1N60	
D13 -22	V11-0271-05	1S2076,1S1555	
D23	V11-0271-05	1S2076,1S1555	E
IC1	V30-0192-05	HA1137K-05	
IC2	V30-0155-05	HA1196-01	
IC3	V30-0196-05	HA1197	
IC4 ,5	V30-0353-10	AN6551	
IC6	V30-0460-10	LC7207	*
IC7	V30-0297-20	TC4069UBP MC14069	
IC7		UP04069	
IC8	V30-0462-10	SN74154N 74154PC	*
IC8		MS3354P HD74154	*
IC9	V30-0459-10	LA5700	*
IC10,11	V30-0264-10	HA1457L	
IC12	V30-0175-05	UPC1024H	
Q1	V03-1923-00	2SC1923	
Q2 ,3	V03-0297-05	2SC945 2SC828A	
Q4	V03-0297-05	2SC945 2SC828A	E
Q5	V09-0144-40	2SK163 2SK136	E
Q6	V09-0144-40	2SK163 2SK136	E
Q7 ,8	V03-0270-05	2SC945 (R,Q) 2SC828A (P,Q)	
Q9 ,10	V09-0144-40	2SK163 2SK136	
Q11	V01-0733-90	2SA733(A) 2SA564A	
Q12	V03-0297-05	2SC945 2SC828A	
Q13	V09-0144-40	2SK163 2SK136	
Q14	V01-0733-90	2SA733(A) 2SA564A	
Q15	V03-0507-05	2SC1567(Q,R,S)	
Q16	V03-0297-05	2SC945 2SC828A	
Q17	V01-0733-90	2SA733(A) 2SA564A	
Q18 -20	V03-0297-05	2SC945 2SC828A	
-	W09-0016-05	BATTERY	*
120 2R	W02-0038-05	FM FRONT END	*
AUDIO AMP (X09-1530-10, 51, 81, X09-1532-71)			
201 2A	B38-0013-05	DISPLAY ASSY	*
202 2A	B38-0014-05	DISPLAY ASSY	*
C1 ,2	C52-1739-16	CERAMIC 390PF K	
C3 ,4	C25-1733-57	LL-ELEC 3.3UF 25WV	
C5 ,6	C25-1710-57	LL-ELEC 1UF 50WV	
C7 ,8	C71-1715-16	CERAMIC 150PF J	
C9 ,10	C71-1705-01	CERAMIC SPF C	
C11 ,12	C26-1710-57	NP-ELEC 1UF 50WV	
C13 ,14	C46-1722-35	MYLAR 0.022UF K	

Ref. No. 参照番号	Parts No. 部品番号	Description 部品名 / 规格	Re- marks 備考
C15 ,16	C46-1710-45	MYLAR 0.1UF K	
C17 ,18	C24-1747-51	ELECTRO 4.7UF 35WV	
C19 ,20	C46-1710-35	MYLAR 0.01UF K	
C21 ,22	C46-1747-35	MYLAR 0.047UF K	
C23 ,24	C71-1718-06	CERAMIC 18PF J	
C25 -28	C71-1747-05	CERAMIC 47PF J	
C29 ,30	C46-1710-45	MYLAR 0.1UF M	
C51	C24-1410-61	ELECTRO 10UF 25WV	
C52	C24-1210-61	ELECTRO 10UF 16WV	
C53	C24-6522-71	ELECTRO 220UF 35WV	
C54	C24-1710-71	ELECTRO 100UF 50WV	
C55	C24-6510-71	ELECTRO 100UF 35WV	
C56 ,57	C24-1710-51	ELECTRO 1UF 50WV	
C58	C24-1222-61	ELECTRO 22UF 16WV	
C81 -83	C24-1410-71	ELECTRO 100UF 25WV	
C84	C24-1210-71	ELECTRO 100UF 16WV	
C85	C24-1722-51	ELECTRO 2.2UF 50WV	
C86	C24-1022-71	ELECTRO 220UF 10WV	
C87 ,88	C24-1447-61	ELECTRO 47UF 25WV	
C89	C24-1033-71	ELECTRO 330UF 10WV	
C90 ,91	C90-0472-05	ELECTROLYTIC CAPACITOR	*
C92 ,93 ,95	C54-2710-39	CERAMIC 0.01UF P	KU
C94	C91-0023-05	CERAMIC 0.01UF AC250V	U
C94	C91-0079-05	CERAMIC 0.01UF AC125V	KC
C94	C91-0079-05	CERAMIC 0.01UF AC125V	T
C92 ,93 ,95	C46-2010-47	CERAMIC 0.1UF M	ET
C96	C71-1715-16	CERAMIC 150PF J	
C97	C24-6510-69	ELECTRO 10UF 35WV	
C98	C24-1022-71	ELECTRO 220UF 10WV	
203 2A	E11-0077-05	PHONE JACK	*
204 1A	E20-0813-05	BINDING POST 8P	*
F1	F05-2521-05	FUSE 250V 2.5A	U
F1	F05-2523-05	FUSE 250V 2.5A	K
F1	F05-2525-05	FUSE 250V T2.5A	C
F2	F05-1222-05	FUSE 250V T1.25A	TE
F2	F05-1521-05	FUSE 250V 1.5A	U
-	J13-0041-05	FUSE HOLDER	KU
-	J13-0054-05	FUSE HOLDER	TE
L1 ,2	L39-0085-05	COIL	
R25 -28	R43-1233-05	FL-PROOF RD33 J 2E	
R29 ,30	R47-5410-05	FL-PROOF RS10 J 3A	
R31 ,32	R47-5447-95	FL-PROOF RS4.7 J 3A	
R35 ,36	R40-8356-16	RC 560 J 2E	
R36	R47-5422-25	FL-PROOF RS2.2K J 3A	
R62	R43-1247-05	FL-PROOF RD47 J 2E	
R67	R47-5456-05	FL-PROOF RS56 J 3A	
R68	R43-1247-95	FL-PROOF RD4.7 J 2E	
R74	R43-1210-25	FL-PROOF RD1K J 2E	
R81	R40-8310-26	RC 1K K 2H	
R84	R40-8310-26	RC 1K K 2H	
R85	R43-1222-15	FL-PROOF RD220 J 2E	
R86 ,87	R47-5556-15	FL-PROOF RS560 J 3D	
R88 ,89	R47-5547-05	FL-PROOF RS47 J 3D	
R93 ,94	R43-1268-05	FL-PROOF RD68 J 2E	
R96	R92-0173-05	RC 2.2M M 2H	
R98	R43-1256-15	FL-PROOF RD560 J 2E	
VR1	R05-7001-05	POTENTIOMETER 205	*
VP2 ,3	R10-4004-05	POTENTIOMETER 206	*
VR4 ,5	R12-3048-05	TRIMMING POT. 100K	
S1	S42-2034-05	PUSH SWITCH 2KEY 207	*

A product of

TRIO-KENWOOD CORPORATION

6-17 3-chome Aobadar Meguro-ku, Tokyo 153, Japan

KENWOOD ELECTRONICS, INC.

1315 E. Watsoncenter Rd. Carson, California 90745, U.S.A

75 Seaview Drive, Secaucus, New Jersey 07094, U.S.A

1098 North Tower Lane Bensenville, Illinois 60106, U.S.A

TRIO-KENWOOD ELECTRONICS, N.V.

Leuvensesteenweg 504 B-1930 Zaventem, Belgium

TRIO-KENWOOD ELECTRONICS GmbH

Rudolf Braas-Str. 20, 6056 Heusenstamm, West Germany

TRIO-KENWOOD FRANCE S.A.

5, Boulevard Ney, 75018 Paris, France

TRIO-KENWOOD SVENSKA AB

Kemistvägen 10A, S-183 21 Taby, Sweden

TRIO-KENWOOD (AUSTRALIA) PTY. LTD.

30 Whiting St., Anarmon, N.S.W. 2064 Australia

KENWOOD & LEE ELECTRONICS, LTD.

Room 501, Wang Kee Building, 5th Floor, 34-37, Connaught Road Central Hong Kong